

MATERIALS

FERRULE	CERAMIC
SLEEVE	CERAMIC
HOUSING	METAL

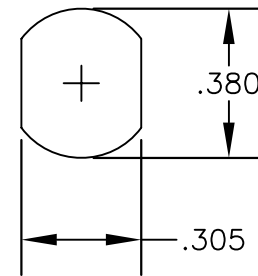
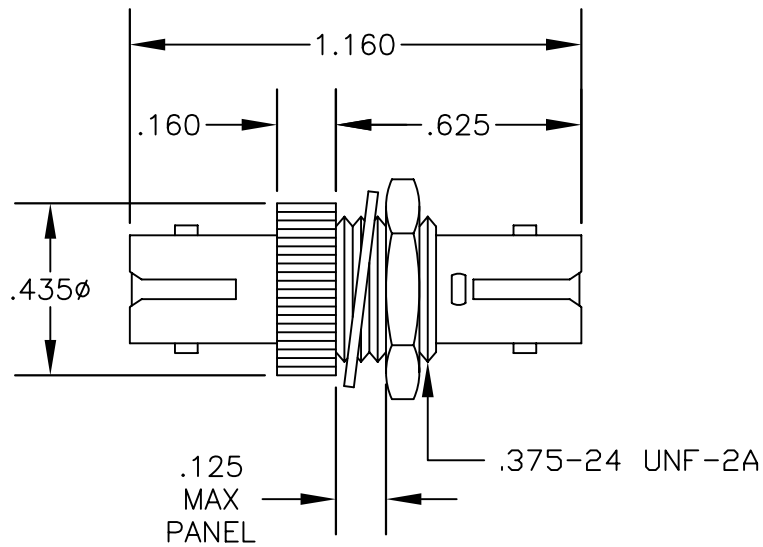

MOUNTING HOLE

SPECIFICATIONS

Single Mode
 PC Polish
 Attenuation Value: 20dB ±10% Typical, ±15% Maximum
 Operating Wavelength: 1300/1550 nm
 Insertion Loss: <0.3dB Typical, 1dB Maximum
 Return Loss: 40 dB Minimum, >50dB Typical
 Operating Temperature: -40°C to +75°C



PASTERNACK ENTERPRISES, INC.
 P.O BOX 16759, IRVINE, CA 92623
 PHONE (949) 261-1920 FAX (949) 261-7451
 WEB ADDRESS: www.pasternack.com
 E-MAIL ADDRESS: sales@pasternack.com
COAXIAL & FIBER OPTICS

DWG TITLE		DES. ST BULKHEAD ATTENUATOR, SINGLE MODE			
PE700003-20					
REV. B	FSCM NO. 53919	CAD FILE 050809	SCALE N/A	SIZE A	147

NOTES:
 1. UNLESS OTHERWISE SPECIFIED ALL DIMENSIONS ARE NOMINAL.
 2. ALL SPECIFICATIONS ARE SUBJECT TO CHANGE WITHOUT NOTICE AT ANY TIME.
 3. DIMENSIONS ARE IN INCHES.