



N Female Bulkhead to SMA Male Right Angle Low Loss Cable Using PE-P160LL Coax

RF Cable Assemblies Technical Data Sheet

PE3C5276

Configuration

- Connector 1: N Female Bulkhead
- Connector 2: SMA Male Right Angle
- Cable Type: PE-P160LL

Features

- Max Frequency 18 GHz
- Shielding Effectivity > 90 dB
- 82.5% Phase Velocity
- Triple Shielded
- FEP Jacket
- 0.8 inch Minimum Bend Radius
- Max VSWR of 1.35:1 to 18 GHz
- Same Day Shipment of Custom Lengths
- RoHS and REACH Compliant

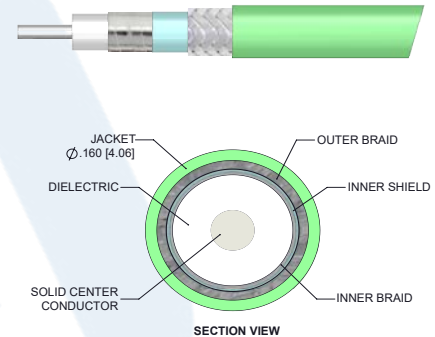

Applications

- General Purpose
- Laboratory Use
- Automated Test Systems
- Airborne Systems
- Phased Arrays
- EW and Countermeasures

Description

The PE3C5276 N Female Bulkhead to SMA Male Right Angle Low Loss cable assembly is part of a series of cable assemblies that use our PE-P160LL double shielded coax. The PE-P160LL based cable assemblies are available in a variety of connector configurations operating to a maximum frequency for this cable series of 18 GHz. The PE3C5276 high performance cable assembly with a 82.5% phase velocity offers very low loss performance in a 0.16 inch coax up to 18 GHz. The shielding effectiveness of the PE-P160LL double shielded coax is greater than 95 dB. The durable stainless steel connectors and FEP cable jacket provide a cost effective design ideal for test environments where a rugged cable assembly is required. A heavy duty heat shrink booting provides improved strain relief and adds to the durability of the cable assembly.

Custom versions of most RF cable assemblies can be built and shipped same day. Custom cable assembly lengths can be obtained by specifying the desired length on the web site at time of order or by contacting a sales representative. Other available RF cable assembly value added services include connector orientation or clocking, heat shrink booting and custom labeling. RF testing can also be performed to document the electrical performance of your cable assembly.

Click the following link (or enter part number in "SEARCH" on website) to obtain additional part information including price, inventory and certifications: [N Female Bulkhead to SMA Male Right Angle Low Loss Cable Using PE-P160LL Coax PE3C5276](#)



N Female Bulkhead to SMA Male Right Angle
Low Loss Cable Using PE-P160LL Coax

RF Cable Assemblies Technical Data Sheet

PE3C5276

Electrical Specifications

Description	Minimum	Typical	Maximum	Units
Frequency Range	DC		18	GHz
VSWR			1.35:1	
Velocity of Propagation		82.5		%
RF Shielding	90			dB
Capacitance		25 [82.02]		pF/ft [pF/m]

Specifications by Frequency

Description	F1	F2	F3	F4	F5	Units
Frequency	1	2	4.5	9	18	GHz
Insertion Loss (Typ.)	0.1	0.14	0.22	0.32	0.46	dB/ft
	0.33	0.46	0.72	1.05	1.51	dB/m

Electrical Specification Notes:

Insertion Loss does not include the loss of the connectors. Insertion Loss is estimated as $0.04 * \sqrt{F(\text{GHz})}$ dB maximum per connector.

Mechanical Specifications

Cable Assembly

Cable

Cable Type	PE-P160LL
Impedance	50 Ohms
Inner Conductor Type	Solid
Inner Conductor Material and Plating	Copper, Silver
Dielectric Type	Expanded PTFE Tape
Number of Shields	3
Shield Layer 1	Silver Plated Copper
Shield Layer 2	Aluminum Polyester
Shield Layer 3	Silver Plated Copper
Jacket Material	FEP
Jacket Diameter	0.16 in [4.06 mm]
Repeated Minimum Bend Radius	0.8 in [20.32 mm]

Click the following link (or enter part number in "SEARCH" on website) to obtain additional part information including price, inventory and certifications: [N Female Bulkhead to SMA Male Right Angle Low Loss Cable Using PE-P160LL Coax PE3C5276](#)



N Female Bulkhead to SMA Male Right Angle
Low Loss Cable Using PE-P160LL Coax

RF Cable Assemblies Technical Data Sheet

PE3C5276

Connectors

Description	Connector 1	Connector 2
Type	N Female Bulkhead	SMA Male Right Angle
Impedance	50 Ohms	50 Ohms
Contact Material and Plating	Beryllium Copper, Gold	Beryllium Copper, Gold
Contact Plating Specification	ASTM-B488	ASTM-B488
Dielectric Type	PTFE	PTFE
Outer Conductor Material and Plating	Passivated Stainless Steel	
Body Material and Plating	Passivated Stainless Steel	Passivated Stainless Steel
Coupling Nut Material and Plating		Passivated Stainless Steel

Environmental Specifications

Temperature

Operating Range

-55 to +165 deg C

Compliance Certifications (see [product page](#) for current document)

Plotted and Other Data

Notes:

Click the following link (or enter part number in "SEARCH" on website) to obtain additional part information including price, inventory and certifications: [N Female Bulkhead to SMA Male Right Angle Low Loss Cable Using PE-P160LL Coax PE3C5276](#)



N Female Bulkhead to SMA Male Right Angle
Low Loss Cable Using PE-P160LL Coax

RF Cable Assemblies Technical Data Sheet

PE3C5276

Typical Performance Data

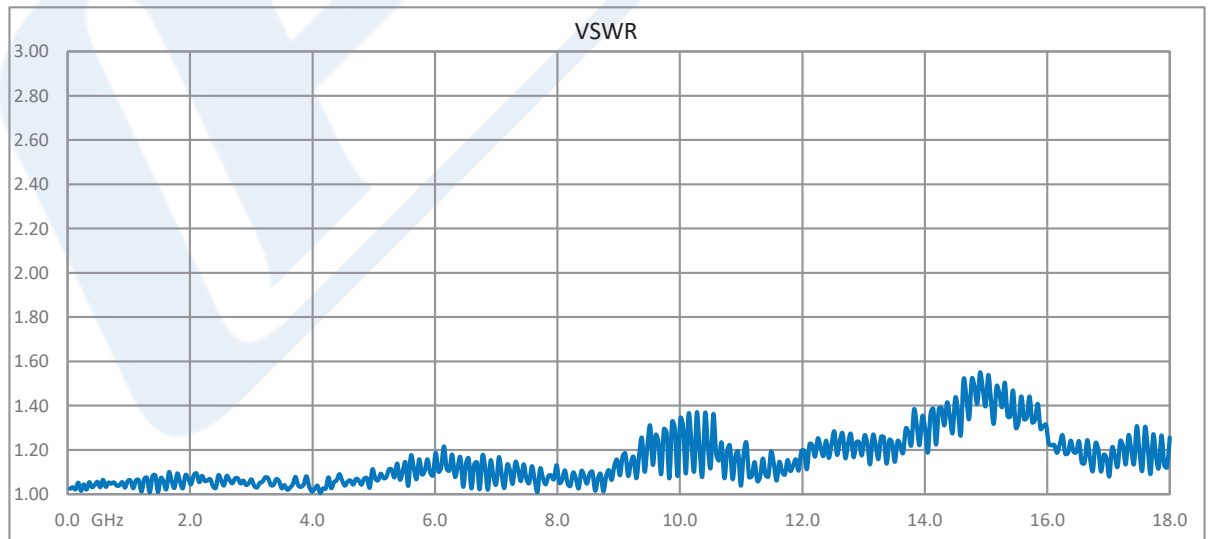
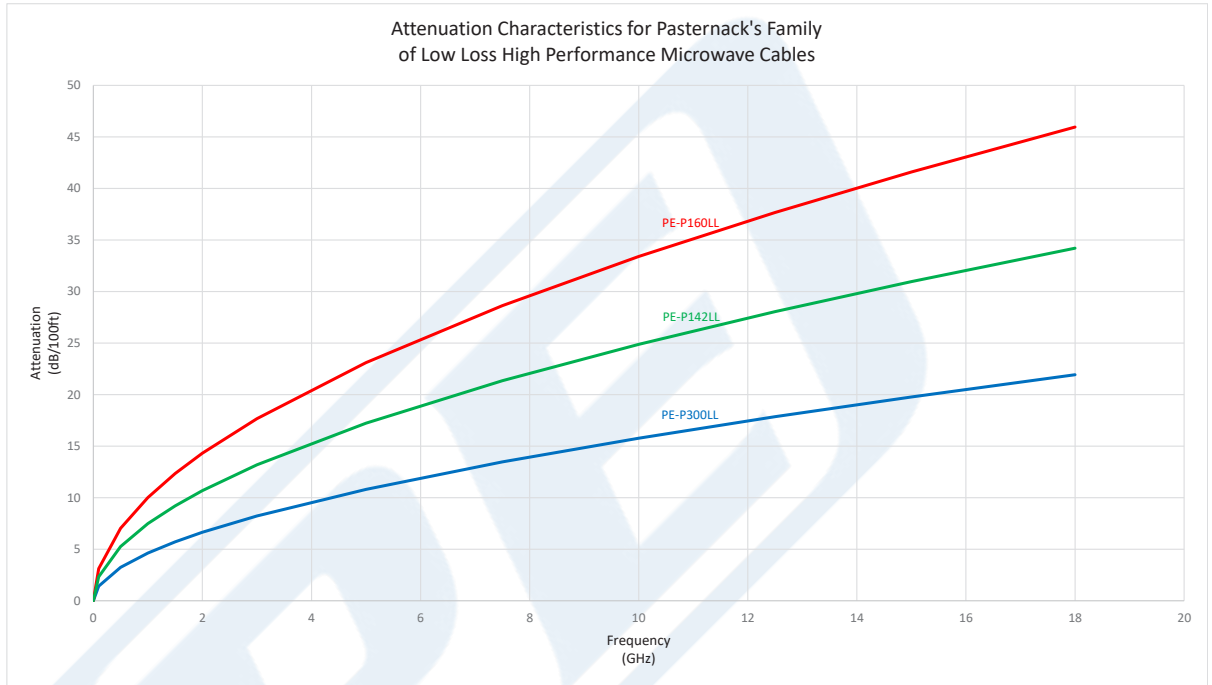

Click the following link (or enter part number in "SEARCH" on website) to obtain additional part information including price, inventory and certifications: [N Female Bulkhead to SMA Male Right Angle Low Loss Cable Using PE-P160LL Coax PE3C5276](#)



N Female Bulkhead to SMA Male Right Angle
Low Loss Cable Using PE-P160LL Coax

RF Cable Assemblies Technical Data Sheet

PE3C5276

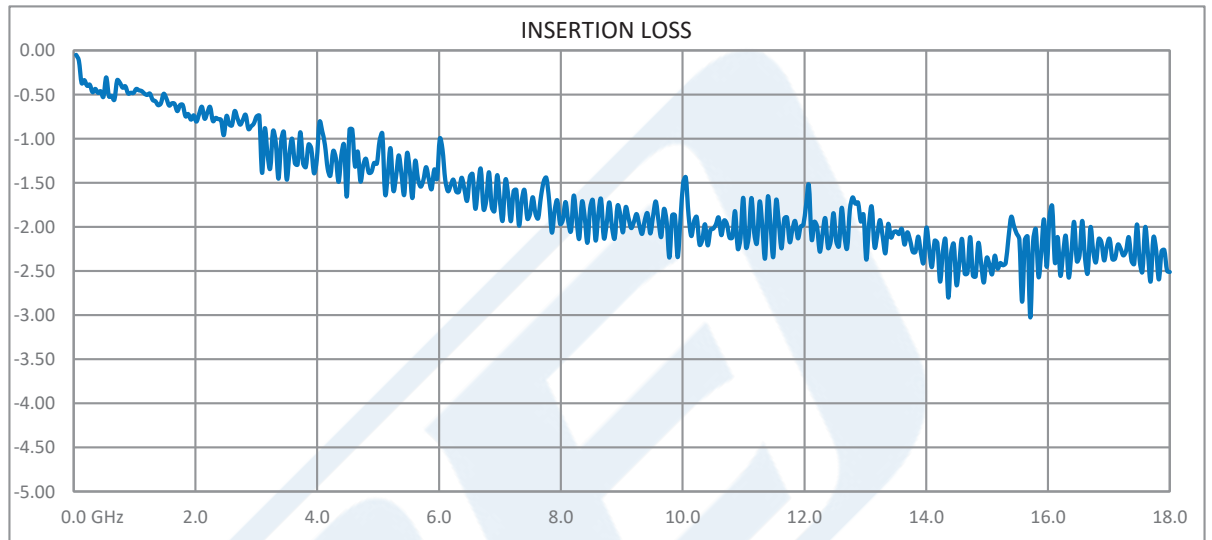

Click the following link (or enter part number in "SEARCH" on website) to obtain additional part information including price, inventory and certifications: [N Female Bulkhead to SMA Male Right Angle Low Loss Cable Using PE-P160LL Coax PE3C5276](#)



N Female Bulkhead to SMA Male Right Angle
Low Loss Cable Using PE-P160LL Coax

RF Cable Assemblies Technical Data Sheet

PE3C5276

How to Order

Part Number Configuration:

PE3C5276

- **xx**

uu

Unit of Measure:
cm = Centimeters
<blank> = Inches
Length
Base Number

Example: PE3C5276-12 = 12 inches long cable
PE3C5276-100cm = 100 cm long cable

N Female Bulkhead to SMA Male Right Angle Low Loss Cable Using PE-P160LL Coax from Pasternack Enterprises has same day shipment for domestic and International orders. Our RF, microwave and millimeter wave products maintain a 99.4% availability and are part of the broadest selection in the industry.

Click the following link (or enter part number in "SEARCH" on website) to obtain additional part information including price, inventory and certifications: [N Female Bulkhead to SMA Male Right Angle Low Loss Cable Using PE-P160LL Coax PE3C5276](https://www.pasternack.com/n-female-sma-male-pe-p160ll-cable-assembly-pe3c5276-p.aspx)

URL: <https://www.pasternack.com/n-female-sma-male-pe-p160ll-cable-assembly-pe3c5276-p.aspx>

The information contained in this document is accurate to the best of our knowledge and representative of the part described herein. It may be necessary to make modifications to the part and/or the documentation of the part, in order to implement improvements. Pasternack reserves the right to make such changes as required. Unless otherwise stated, all specifications are nominal. Pasternack does not make any representation or warranty regarding the suitability of the part described herein for any particular purpose, and Pasternack does not assume any liability arising out of the use of any part or documentation.

PE3C5276 CAD Drawing

N Female Bulkhead to SMA Male Right Angle Low Loss Cable Using PE-P160LL Coax

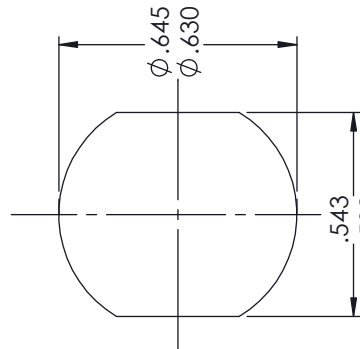
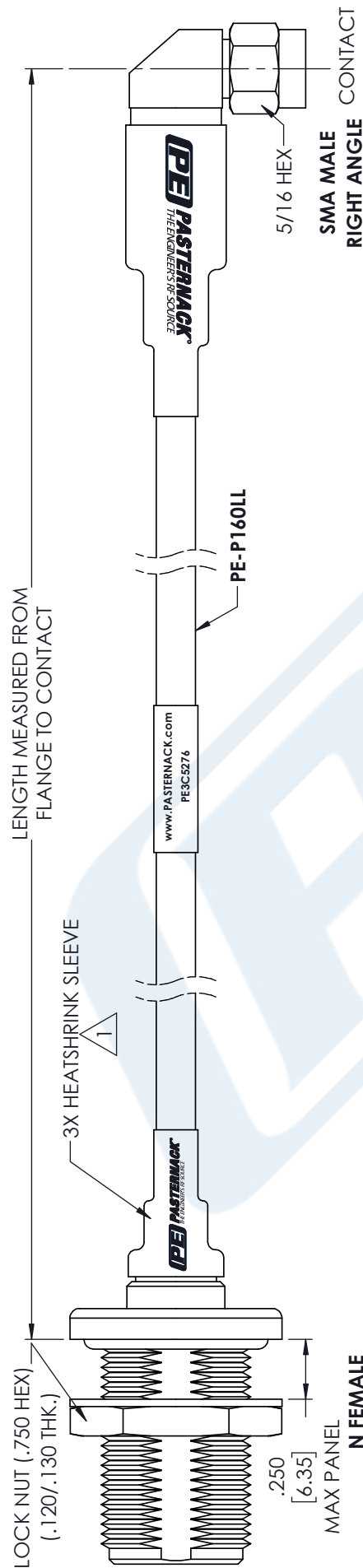

STANDARD TOLERANCES	
.X	±0.2
.XX	±0.01
.XXX	±0.005

NOTES:

- *STANDARD TOLERANCES APPLY ONLY TO DIMENSIONS IN INCHES
- 1. BLACK HEAT SHRINK WITH WHITE MARKINGS 3 PLACES.

 PASTERNAK <small>THE ENGINEER'S RF SOURCE</small> Pastermack Enterprises, Inc. P.O. Box 16759 Irvine CA 92623 Phone: (949) 261-1920 Fax: (949) 261-7451 Website: www.pasternack.com E-Mail: sales@pasternack.com	DWG TITLE PE3C5276	NOTES: 1. UNLESS OTHERWISE SPECIFIED ALL DIMENSIONS ARE NOMINAL. 2. ALL SPECIFICATIONS ARE SUBJECT TO CHANGE WITHOUT NOTICE AT ANY TIME. 3. DIMENSIONS ARE IN INCHES [mm].	
	CAGE CODE 53919	CAD FILE 07/16/18	SCALE N/A
© 2020 Pasternack Enterprises All Rights Reserved		PE3C5276 REV 1.2	SIZE A CN2379