



2.92mm Male Connector Clamp/Solder (Captive Contact) Attachment End Launch PCB, Removable End Launch, Standard Profile

RF Connectors Technical Data Sheet

PE45509

Configuration

- 2.92mm Male Connector
- 50 Ohms
- Straight Body Geometry
- End Launch Interface Type
- Clamp/Solder (Captive Contact) Attachment

Features

- Max. Operating Frequency 40 GHz
- Good VSWR of 1.4:1
- Gold Plated Beryllium Copper Contact
- Reusable end launch installation
- PCB Solder or Solderless Contact
- M1.6-0.35 Mounting Screws

Applications

- General Purpose Test
- PCB Applications
- Coplanar Waveguide Edge Launches
- Signal Integrity Measurements
- Chip Evaluations
- SERDES
- 25 GbE
- Substrate Characterization
- Test Fixtures

Description

Pasternack's PE45509 2.92mm removable end launch PCB connector is part of our full line of RF components available for same-day shipping. Our 2.92mm solderless edge launch connector operates to a maximum frequency of 40 GHz and offers a low VSWR of 1.4:1. The clamp-on removable design allows this connector to be reused, supporting multiple chip evaluations, signal integrity and millimeter wave applications.

Our 2.92mm solderless end launch PCB connector PE45509 datasheet specifications and drawing with dimensions are shown below in this PDF. Pasternack's broad catalog of RF, microwave and millimeter wave connectors allows designers to configure and customize their signal connections however they like. Whether the need is to provide superior signal integrity, higher data rates or simply a test fixture, Pasternack has the right high speed PCB edge launch connections for you.

Electrical Specifications

Description	Minimum	Typical	Maximum	Units
Frequency Range	DC		40	GHz
VSWR			1.4:1	
Insertion Loss			0.38	dB
Operating Voltage (AC)			400	Vrms

Electrical Specification Notes:

Actual VSWR performance is largely dependent on circuit board design. For optimal results, the connector and circuit launch geometry should be modeled using Electromagnetic Simulation tools.

Click the following link (or enter part number in "SEARCH" on website) to obtain additional part information including price, inventory and certifications: [2.92mm Male Connector Clamp/Solder \(Captive Contact\) Attachment End Launch PCB, Removable End Launch, Standard Profile PE45509](#)



2.92mm Male Connector Clamp/Solder (Captive Contact) Attachment End Launch PCB, Removable End Launch, Standard Profile

RF Connectors
Technical Data Sheet

PE45509

Mechanical Specifications

Size

Length 0.871 in [22.12 mm]
Width/Dia. 0.5 in [12.70 mm]
Height 0.5 in [12.7 mm]

Material Specifications

Description	Material	Plating
Contact	Beryllium Copper	Gold
Insulation	PEI	
Body	Passivated Stainless Steel	
Coupling Nut	Passivated Stainless Steel	

Mechanical Specification Notes:
Launch Pin is Gold Plated Beryllium Copper

Environmental Specifications

Temperature

Operating Range -40 to +125 deg C

Compliance Certifications (see [product page](#) for current document)

Plotted and Other Data

Notes:

Click the following link (or enter part number in "SEARCH" on website) to obtain additional part information including price, inventory and certifications: [2.92mm Male Connector Clamp/Solder \(Captive Contact\) Attachment End Launch PCB, Removable End Launch, Standard Profile PE45509](#)



2.92mm Male Connector Clamp/Solder (Captive Contact) Attachment End Launch PCB, Removable End Launch, Standard Profile

RF Connectors
Technical Data Sheet

PE45509

Assembly Instruction

Step 1: Mount the end launch connector in the desired position on the board.

Step 2: Center the connector on the trace.

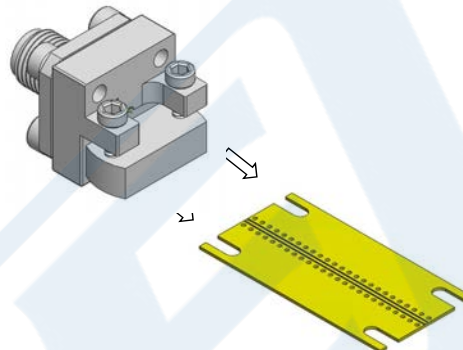

Step 3: Verify that the transition block is secured on the board.

Step 4: Tighten the M1.6-0.35 mounting screws to the boards suggested torque or until the connectors is secure.

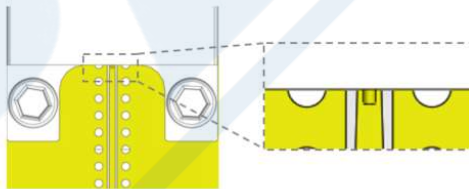

(Steps 5-7 optional, depending on application)

Step 5: If soldering the launch pin to the trace, flow solder the entire length of the contact area.

Step 6: To avoid performance mistakes, remove excess solder.

Step 7: Clean any residue from around the solder joint.

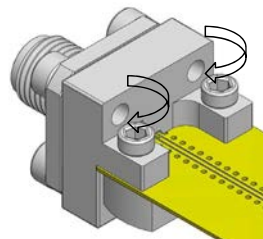

Click the following link (or enter part number in "SEARCH" on website) to obtain additional part information including price, inventory and certifications: [2.92mm Male Connector Clamp/Solder \(Captive Contact\) Attachment End Launch PCB, Removable End Launch, Standard Profile PE45509](#)



2.92mm Male Connector Clamp/Solder (Captive Contact) Attachment End Launch PCB, Removable End Launch, Standard Profile

RF Connectors
Technical Data Sheet

PE45509

Recommended PCB Cutouts

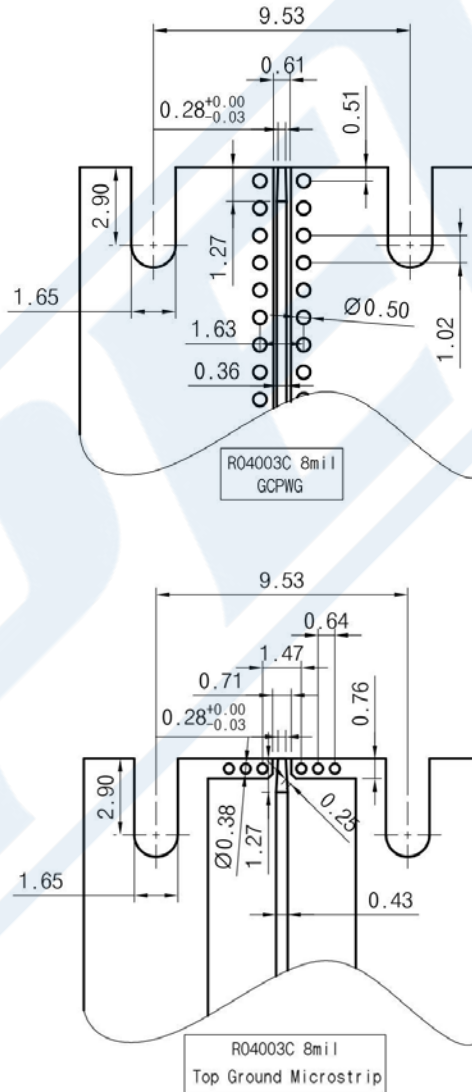

Click the following link (or enter part number in "SEARCH" on website) to obtain additional part information including price, inventory and certifications: [2.92mm Male Connector Clamp/Solder \(Captive Contact\) Attachment End Launch PCB, Removable End Launch, Standard Profile PE45509](#)



2.92mm Male Connector Clamp/Solder (Captive Contact) Attachment End Launch PCB, Removable End Launch, Standard Profile

RF Connectors
Technical Data Sheet

PE45509

Typical Performance Data

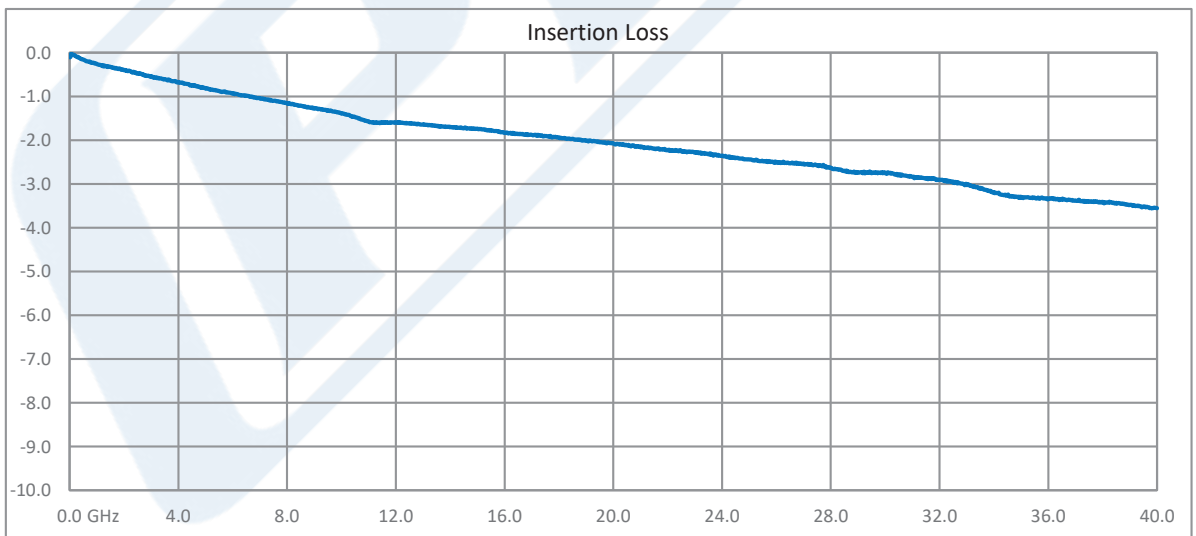
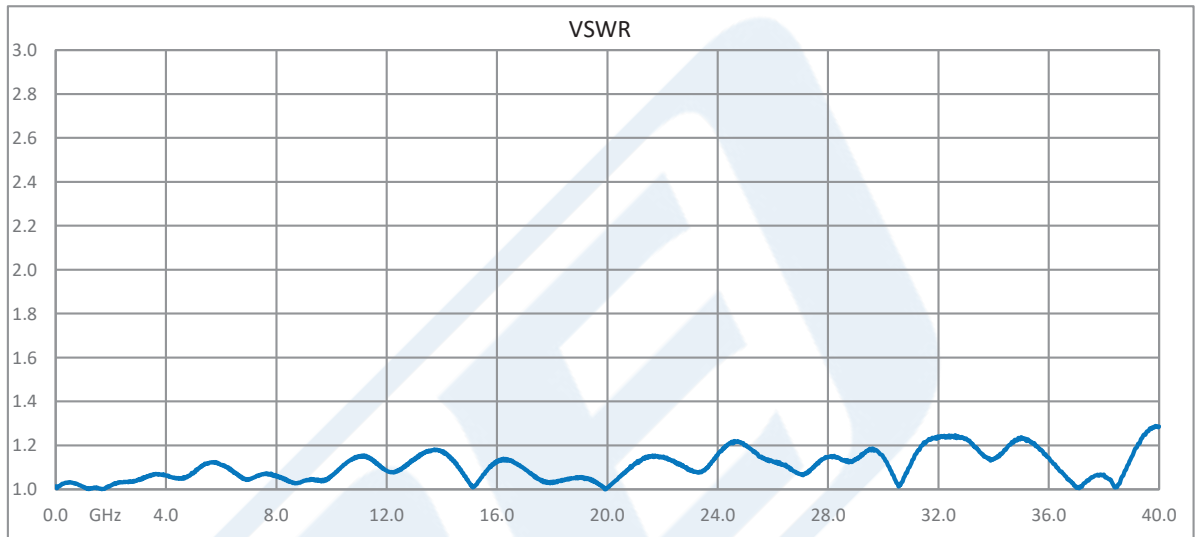

Measurement is for two connectors with 1.0 inch (25.4mm) length of substrate

Click the following link (or enter part number in "SEARCH" on website) to obtain additional part information including price, inventory and certifications: [2.92mm Male Connector Clamp/Solder \(Captive Contact\) Attachment End Launch PCB, Removable End Launch, Standard Profile PE45509](#)



2.92mm Male Connector Clamp/Solder (Captive Contact) Attachment End Launch PCB, Removable End Launch, Standard Profile

RF Connectors
Technical Data Sheet

PE45509

2.92mm Male Connector Clamp/Solder (Captive Contact) Attachment End Launch PCB, Removable End Launch, Standard Profile from Pasternack Enterprises has same day shipment for domestic and International orders. Our RF, microwave and millimeter wave products maintain a 99.4% availability and are part of the broadest selection in the industry.

Click the following link (or enter part number in "SEARCH" on website) to obtain additional part information including price, inventory and certifications: [2.92mm Male Connector Clamp/Solder \(Captive Contact\) Attachment End Launch PCB, Removable End Launch, Standard Profile PE45509](https://www.pasternack.com/2.92mm-male-end-launch-pcb-connector-pe45509-p.aspx)

URL: <https://www.pasternack.com/2.92mm-male-end-launch-pcb-connector-pe45509-p.aspx>

The information contained in this document is accurate to the best of our knowledge and representative of the part described herein. It may be necessary to make modifications to the part and/or the documentation of the part, in order to implement improvements. Pasternack reserves the right to make such changes as required. Unless otherwise stated, all specifications are nominal. Pasternack does not make any representation or warranty regarding the suitability of the part described herein for any particular purpose, and Pasternack does not assume any liability arising out of the use of any part or documentation.

PE45509 CAD Drawing

2.92mm Male Connector Clamp/Solder (Captive Contact) Attachment
End Launch PCB, Removable End Launch, Standard Profile

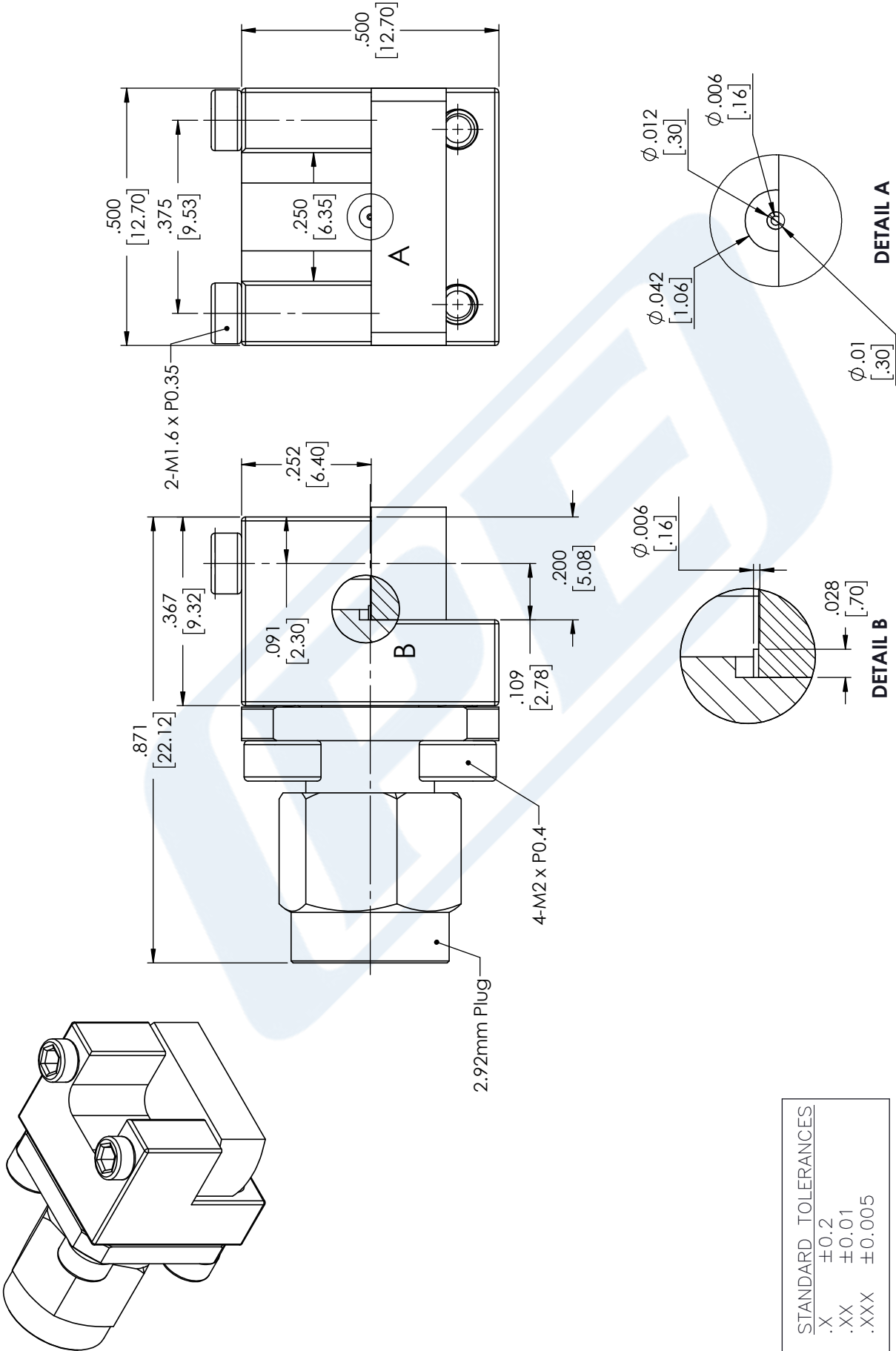

STANDARD TOLERANCES	
.X	±0.2
.XX	±0.01
.XXX	±0.005

*STANDARD TOLERANCES APPLY ONLY TO DIMENSIONS IN INCHES

NOTES:
1. UNLESS OTHERWISE SPECIFIED ALL DIMENSIONS ARE NOMINAL.
2. ALL SPECIFICATIONS ARE SUBJECT TO CHANGE WITHOUT NOTICE AT ANY TIME.
3. DIMENSIONS ARE IN INCHES [mm].

DWG TITLE
PE45509

PASTERNAK
THE ENGINEER'S RF SOURCE
Pasternack Enterprises, Inc.
P.O. Box 16759 | Irvine | CA | 92623
Phone: (949) 261-1920 | Fax: (949) 261-7451
Website: www.pasternack.com | E-Mail: sales@pasternack.com

CAD FILE 09/12/18

CAGE CODE 53919

SCALE N/A

SIZE A

CN2245