



6 dB Fixed Attenuator, N Male to N Female Black Anodized Aluminum Heatsink Body Rated to 10 Watts Up to 2 GHz

RF Fixed Attenuators Technical Data Sheet

PE7010-6

Features

- Bidirectional
- DC to 2 GHz Frequency Range
- Attenuation 6±1 dB
- Max Power 10 Watts (CW)
- VSWR < 1.6:1

Applications

- Instrumentation
- Precision measurements
- Prototyping and characterization
- Production systems

Description

Pasternack carries a wide range of fixed attenuators with a broad selection of attenuation levels, frequency ranges, and power dissipation ranges. RF microwave attenuators (also known as RF pads) lower the amplitude of a signal (attenuate) a known amount and can be used in a wide variety of applications. These attenuator pads are used when a signal needs to be reduced to protect measurement equipment or other circuitry, to extend the range of power meters and amplifiers, and to impedance match circuits by reducing the VSWR seen by adjacent components. RF attenuators can prevent signal overload in amplifiers, receivers and detectors, adjusting the signal level to a range that is optimal.

Few RF components are as commonly used as fixed coaxial attenuators, and Pasternack carries one of the largest in-stock varieties and ships them same day. The 6 dB Fixed Attenuator PE7010-6 is rated to 10 Watts and operates from DC to 2 GHz. The versatile coaxial package uses N male to N female connectors and is also REACH and RoHS compliant. The Black Anodized Aluminum Heatsink body allows for efficient heat dissipation under high power usage conditions.

Electrical Specifications

Description	Minimum	Typical	Maximum	Units
Frequency Range	DC		2	GHz
Impedance		50		Ohms
Nominal Attenuation		6		dB
VSWR			1.6:1	
Input Power, CW derated linearly to 2W at +125°C			10	Watts
Input Power, Peak 5µs pulse, 0.05% duty cycle			500	Watts

Click the following link (or enter part number in "SEARCH" on website) to obtain additional part information including price, inventory and certifications: [6 dB Fixed Attenuator, N Male to N Female Black Anodized Aluminum Heatsink Body Rated to 10 Watts Up to 2 GHz PE7010-6](#)



6 dB Fixed Attenuator, N Male to N Female Black Anodized Aluminum Heatsink Body Rated to 10 Watts Up to 2 GHz

RF Fixed Attenuators Technical Data Sheet

PE7010-6

Specifications by Frequency

Description	F1	F2	F3	F4	F5	Units
Range	DC to 1	1 to 2				GHz
VSWR, Max	1.3:1	1.6:1				
Attenuation Accuracy, Typ	±0.7	±1				dB

Mechanical Specifications

Size

Length	2.41 in [61.21 mm]
Width/Diameter	1 in [25.4 mm]
Weight	0.158 lbs [71.67 g]
Body Material and Plating	Black Anodized Aluminum Heatsink

Configuration

Design	Fixed, Bidirectional
Package Style	Connectorized Module

Connectors

Description	Connector 1	Connector 2
Type	N Male	N Female
Connector Specification	MIL-STD-348	MIL-STD-348
Contact Material and Plating	Beryllium Copper, Gold	Beryllium Copper, Gold
Body Material and Plating	Passivated Stainless Steel	Passivated Stainless Steel

Environmental Specifications

Temperature

Operating Range	-65 to +125 deg C
-----------------	-------------------

Compliance Certifications (visit www.Pasternack.com for current document)

RoHS Compliant	
REACH Compliant	12/17/2015

Plotted and Other Data

Notes:

Click the following link (or enter part number in "SEARCH" on website) to obtain additional part information including price, inventory and certifications: [6 dB Fixed Attenuator, N Male to N Female Black Anodized Aluminum Heatsink Body Rated to 10 Watts Up to 2 GHz PE7010-6](#)



6 dB Fixed Attenuator, N Male to N Female Black Anodized
Aluminum Heatsink Body Rated to 10 Watts Up to 2 GHz

RF Fixed Attenuators Technical Data Sheet

PE7010-6

6 dB Fixed Attenuator, N Male to N Female Black Anodized Aluminum Heatsink Body Rated to 10 Watts Up to 2 GHz from Pasternack Enterprises has same day shipment for domestic and International orders. Our RF, microwave and millimeter wave products maintain a 99% availability and are part of the broadest selection in the industry.

Click the following link (or enter part number in "SEARCH" on website) to obtain additional part information including price, inventory and certifications: [6 dB Fixed Attenuator, N Male to N Female Black Anodized Aluminum Heatsink Body Rated to 10 Watts Up to 2 GHz PE7010-6](http://www.pasternack.com/6db-fixed-n-female-n-male-10-watts-attenuator-pe7010-6-p.aspx)

URL: <http://www.pasternack.com/6db-fixed-n-female-n-male-10-watts-attenuator-pe7010-6-p.aspx>

PE7010-6 CAD Drawing

6 dB Fixed Attenuator, N Male to N Female Black Anodized Aluminum Heatsink Body Rated to 10 Watts Up to 2 GHz

P/N	ATTEN.	FIGURE
PE7010-2	2 dB	1
PE7010-3	3 dB	1
PE7010-6	6 dB	1
PE7010-10	10 dB	1
PE7010-20	20 dB	1
PE7010-30	30 dB	2
PE7010-40	40 dB	2

STANDARD TOLERANCES
 .X ±0.2
 .XX ±0.1
 .XXX ±0.05

*STANDARD TOLERANCES APPLY ONLY TO DIMENSIONS IN INCHES

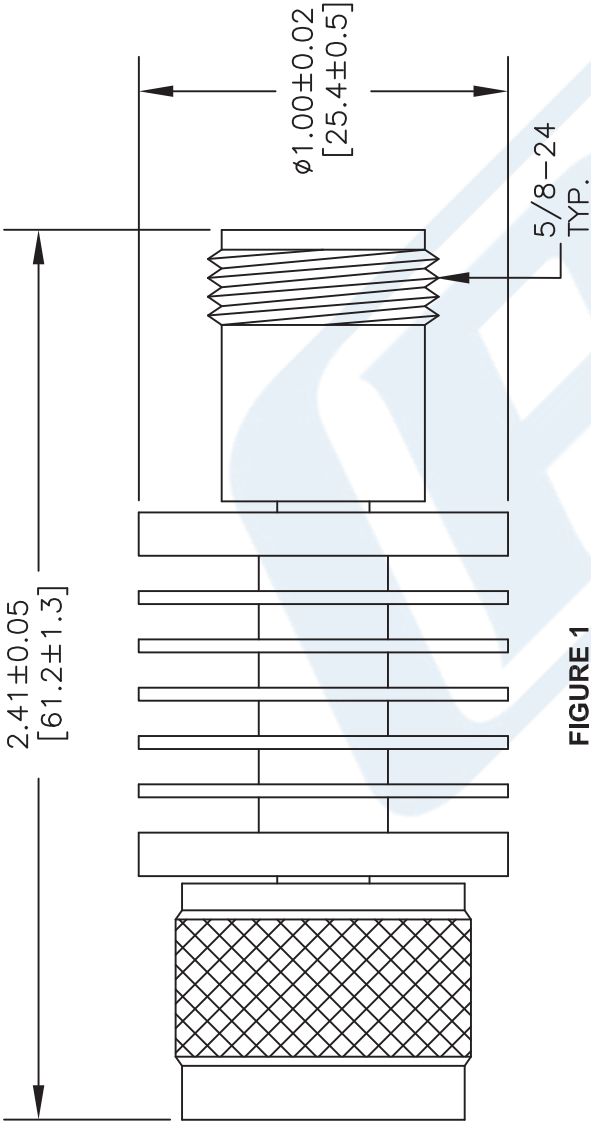

FIGURE 1

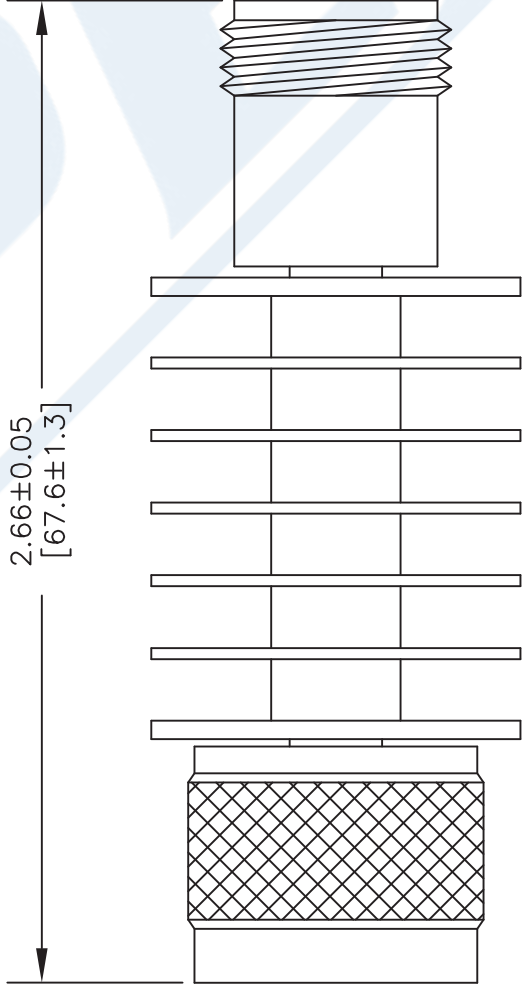
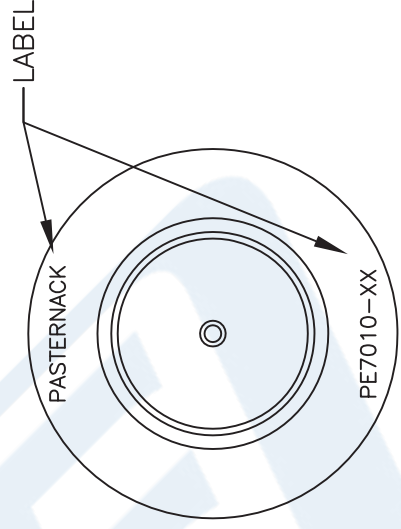

FIGURE 2



N FEMALE

N MALE

NOTES:
 1. UNLESS OTHERWISE SPECIFIED ALL DIMENSIONS ARE NOMINAL.
 2. ALL SPECIFICATIONS ARE SUBJECT TO CHANGE WITHOUT NOTICE AT ANY TIME.
 3. DIMENSIONS ARE IN INCHES [mm].

DWG TITLE
PE7010

(PE) PASTERNAK®
 THE ENGINEER'S RF SOURCE
 Pasternack Enterprises, Inc.
 P.O. Box 16759 | Irvine | CA | 92623
 Phone: (949) 261-1920 | Fax: (949) 261-7451
 Website: www.pasternack.com | E-Mail: sales@pasternack.com

CAD FILE	022516	SCALE	N/A	SIZE	A	3045
----------	--------	-------	-----	------	---	------