



0.5 inch Hermetic Surface Mount (SMT) Voltage Controlled Oscillator (VCO) From 18 MHz to 30 MHz With Phase Noise of -120 dBc/Hz

Voltage Control Oscillators Technical Data Sheet

PE1V13001

Features

- 18 to 30 MHz Bandwidth
- -120 dBc/Hz @ 10kHz offset
- Tuning Voltage 0.5V to 12V
- Pout = +12 dBm
- Harmonics = -13 dBm
- RoHs Compliant Assembly
- Hermetically Sealed Rugged SMT Package
- Designed to meet Fine & Gross leak per MIL-STD-883 Method 1014
- Designed to meet MIL-STD-202 Environmental Conditions

Applications

- Phase Locked Loop
- Function Generators
- Frequency Synthesizers
- Receivers
- Electronic Jamming Equipment
- Local Oscillator
- Wireless Communications
- SATCOM
- Optical Communications
- Military Electronic Systems

Description

The PE1V13001 is a High Reliability Low Noise Voltage Controlled Oscillator (VCO) which covers a 18 MHz to 30 MHz frequency band with a voltage tuning range from 0.5V to 12V. This design features exceptional phase noise performance of -120 dBc/Hz @ 10 kHz offset. Supply Voltage is +12V with a generated output power level of +12.0 dBm and 2nd harmonic output of -13 dBc typical. The assembly is RoHs compliant and available in a hermetically sealed 0.5" surface mount package with exposed leads that MIL-STD-883, Method 1014 fine & Gross leak conditions. This rugged package operates over a temperature range of -40oC to +85oC and is designed to also meet a variety of MIL-STD-202 test conditions including Humidity, Shock, and Vibration.

Electrical Specifications

Description	Minimum	Typical	Maximum	Units
Frequency Range	18		30	MHz
Tuning Voltage	0		12	Vdc
Supply Voltage (DC)	11	12	13	Vdc
Supply Current (DC)		16	19	mA
Phase Noise @ 1kHz Offset		-95	-92	dBc/Hz
Phase Noise @ 10kHz Offset		-120	-118	dBc/Hz
Phase Noise @ 100kHz Offset		-140	-138	dBc/Hz
Output Power	+10	+12	+13.5	dBm
Tuning Sensitivity (Kvco)	0.9		1.8	MHz/V
Pushing		0.03	0.05	MHz/Volt
Pulling (pk-pk)		70	100	KHz
Tuning Port Capacitance		100		pF
Load Impedance		50		Ohms
2nd Harmonics		-13	-12	dBc

Click the following link (or enter part number in "SEARCH" on website) to obtain additional part information including price, inventory and certifications: [0.5 inch Hermetic Surface Mount \(SMT\) Voltage Controlled Oscillator \(VCO\) From 18 MHz to 30 MHz With Phase Noise of -120 dBc/Hz PE1V13001](#)



0.5 inch Hermetic Surface Mount (SMT) Voltage
Controlled Oscillator (VCO) From 18 MHz to
30 MHz With Phase Noise of -120 dBc/Hz

Voltage Control Oscillators Technical Data Sheet

PE1V13001

Mechanical Specifications

Size

Length	0.5 in [12.7 mm]
Width	0.5 in [12.7 mm]
Height	0.215 in [5.46 mm]
Weight	0.02 lbs [9.07 g]
Mounting Surface Material and Plating	Copper Clad, Nickel, Gold
Design	Hermetic
Package Style	Surface Mount

Environmental Specifications

Temperature

Operating Range	-40 to +85 deg C
Storage Range	-55 to +125 deg C

Humidity	MIL-STD-202, Method 103, 90% RH, +65 C
Shock	MIL-STD-202, Method 213I
Vibration	MIL-STD-202, Method 204D
Temperature Cycle	MIL-STD-202, Method 107B
Thermal Shock	MIL-STD-883, Method 1014A, 1 x 10 ⁻⁸ atm cc/s
Hermetic Seal	MIL-STD-883 Method 1014C
ESD Sensitivity	ESD Sensitive Material, Transport material in Approved ESD bags. Handle only in ESD Workstation.



Compliance Certifications (visit www.Pasternack.com for current document)

RoHS Compliant	
REACH Compliant	12/17/2015

Plotted and Other Data

Notes:

Click the following link (or enter part number in "SEARCH" on website) to obtain additional part information including price, inventory and certifications: [0.5 inch Hermetic Surface Mount \(SMT\) Voltage Controlled Oscillator \(VCO\) From 18 MHz to 30 MHz With Phase Noise of -120 dBc/Hz PE1V13001](#)



0.5 inch Hermetic Surface Mount (SMT) Voltage Controlled Oscillator (VCO) From 18 MHz to 30 MHz With Phase Noise of -120 dBc/Hz

Voltage Control Oscillators Technical Data Sheet

PE1V13001

Typical Performance Data

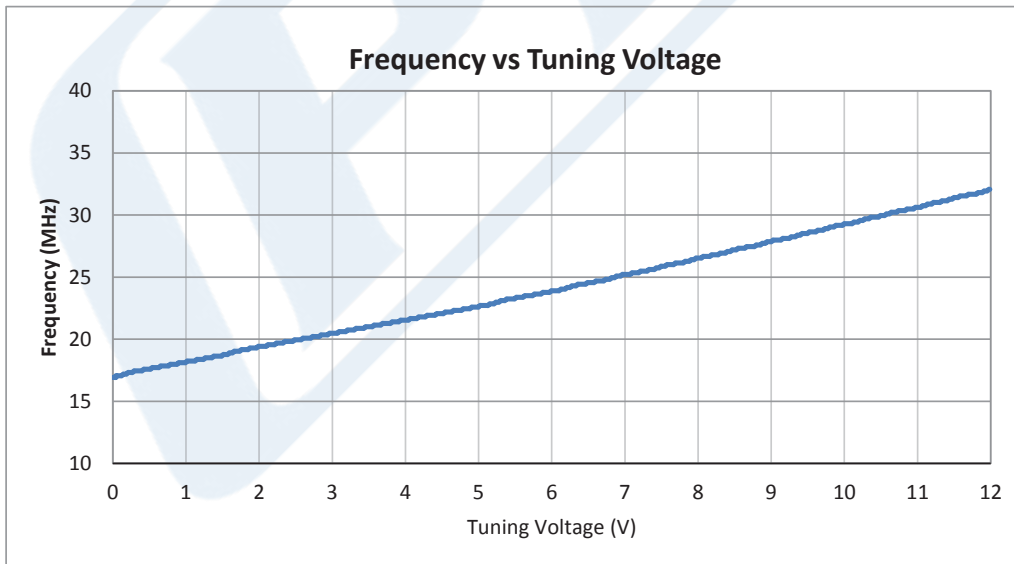
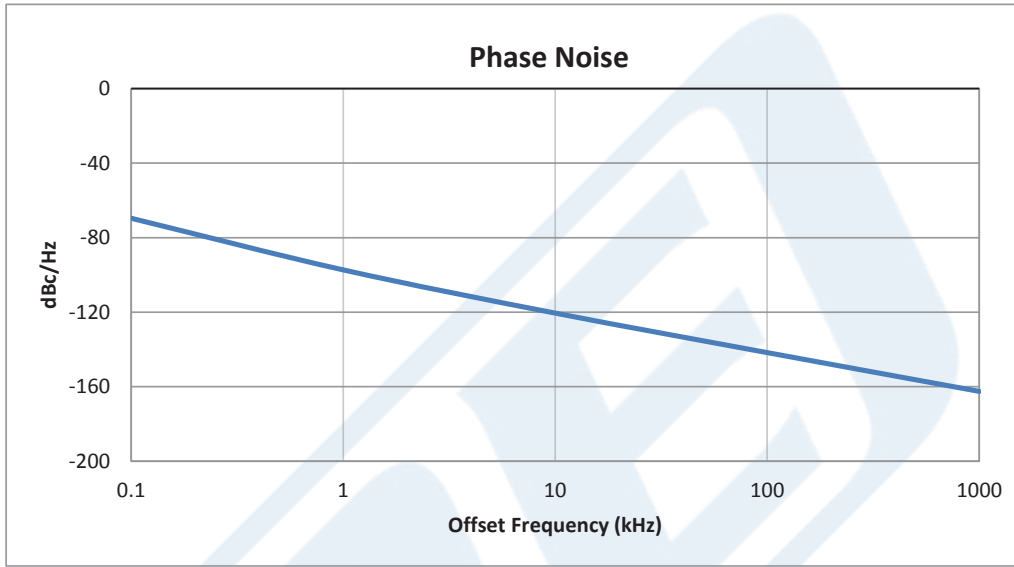

Click the following link (or enter part number in "SEARCH" on website) to obtain additional part information including price, inventory and certifications: [0.5 inch Hermetic Surface Mount \(SMT\) Voltage Controlled Oscillator \(VCO\) From 18 MHz to 30 MHz With Phase Noise of -120 dBc/Hz PE1V13001](#)



0.5 inch Hermetic Surface Mount (SMT) Voltage
Controlled Oscillator (VCO) From 18 MHz to
30 MHz With Phase Noise of -120 dBc/Hz

Voltage Control Oscillators Technical Data Sheet

PE1V13001

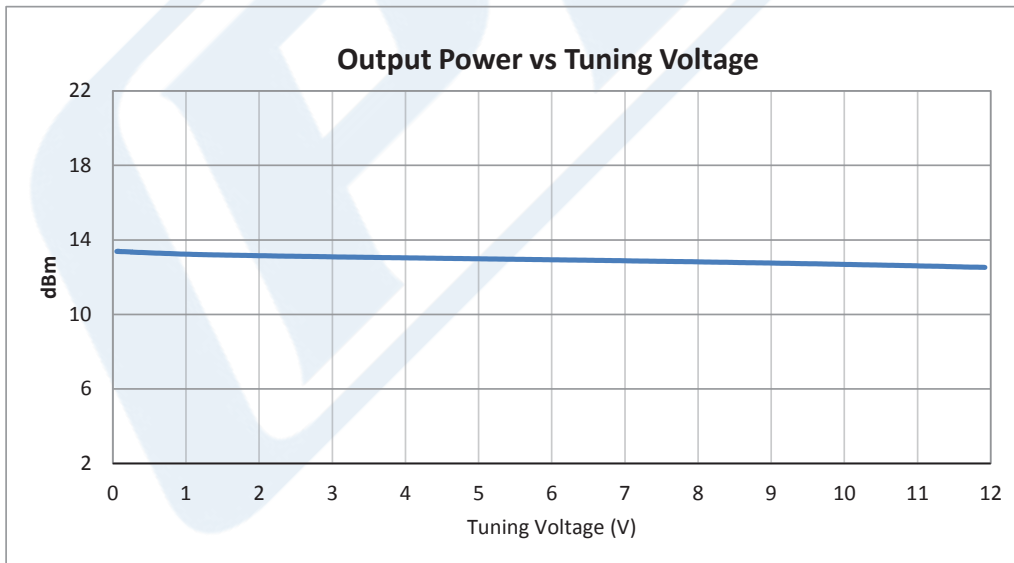
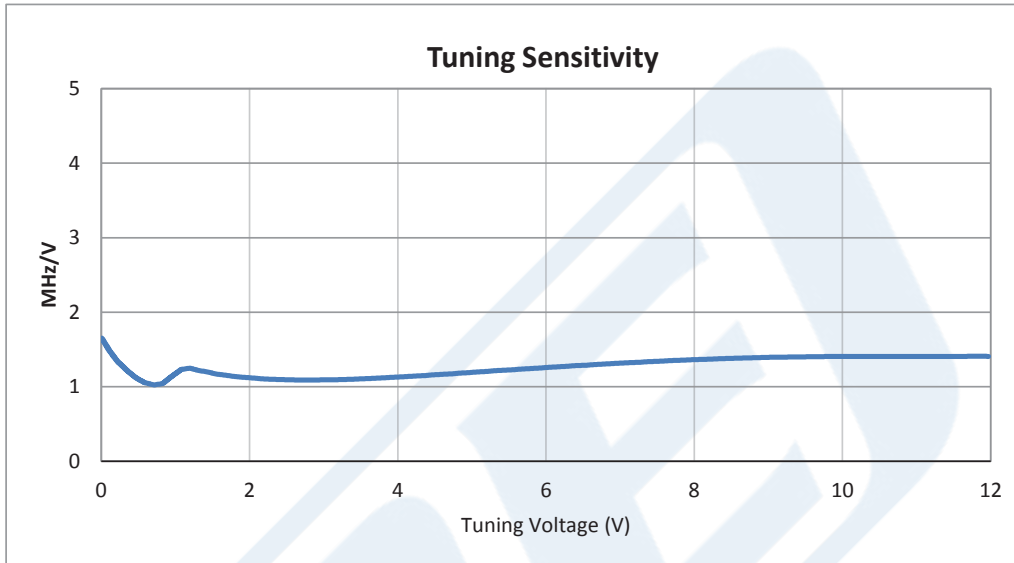

Click the following link (or enter part number in "SEARCH" on website) to obtain additional part information including price, inventory and certifications: [0.5 inch Hermetic Surface Mount \(SMT\) Voltage Controlled Oscillator \(VCO\) From 18 MHz to 30 MHz With Phase Noise of -120 dBc/Hz PE1V13001](#)



0.5 inch Hermetic Surface Mount (SMT) Voltage Controlled Oscillator (VCO) From 18 MHz to 30 MHz With Phase Noise of -120 dBc/Hz

Voltage Control Oscillators Technical Data Sheet

PE1V13001

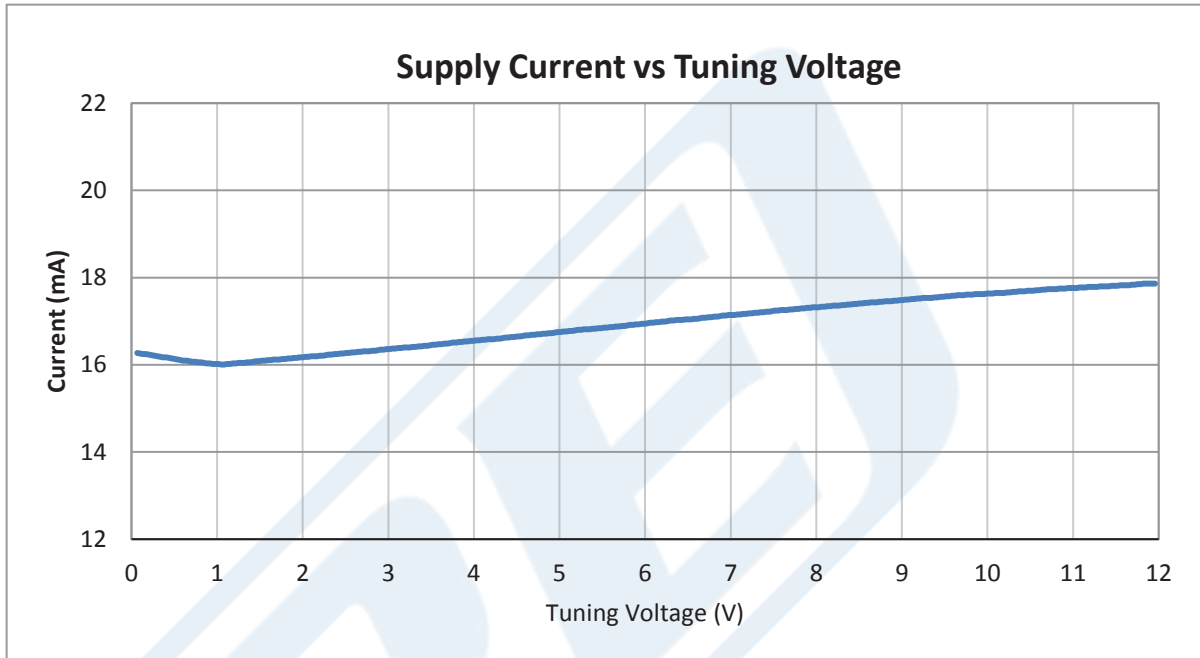

0.5 inch Hermetic Surface Mount (SMT) Voltage Controlled Oscillator (VCO) From 18 MHz to 30 MHz With Phase Noise of -120 dBc/Hz from Pasternack Enterprises has same day shipment for domestic and International orders. Our RF, microwave and millimeter wave products maintain a 99% availability and are part of the broadest selection in the industry.

Click the following link (or enter part number in "SEARCH" on website) to obtain additional part information including price, inventory and certifications: [0.5 inch Hermetic Surface Mount \(SMT\) Voltage Controlled Oscillator \(VCO\) From 18 MHz to 30 MHz With Phase Noise of -120 dBc/Hz PE1V13001](http://www.pasternack.com/surface-mount-smt-voltage-controlled-oscillator-vco-30-mhz-pe1v13001-p.aspx)

URL: <http://www.pasternack.com/surface-mount-smt-voltage-controlled-oscillator-vco-30-mhz-pe1v13001-p.aspx>

The information contained in this document is accurate to the best of our knowledge and representative of the part described herein. It may be necessary to make modifications to the part and/or the documentation of the part, in order to implement improvements. Pasternack reserves the right to make such changes as required. Unless otherwise stated, all specifications are nominal. Pasternack does not make any representation or warranty regarding the suitability of the part described herein for any particular purpose, and Pasternack does not assume any liability arising out of the use of any part or documentation.

PE1V13001 CAD Drawing

0.5 inch Hermetic Surface Mount (SMT) Voltage Controlled Oscillator (VCO) From 18 MHz to 30 MHz With Phase Noise of -120 dBc/Hz

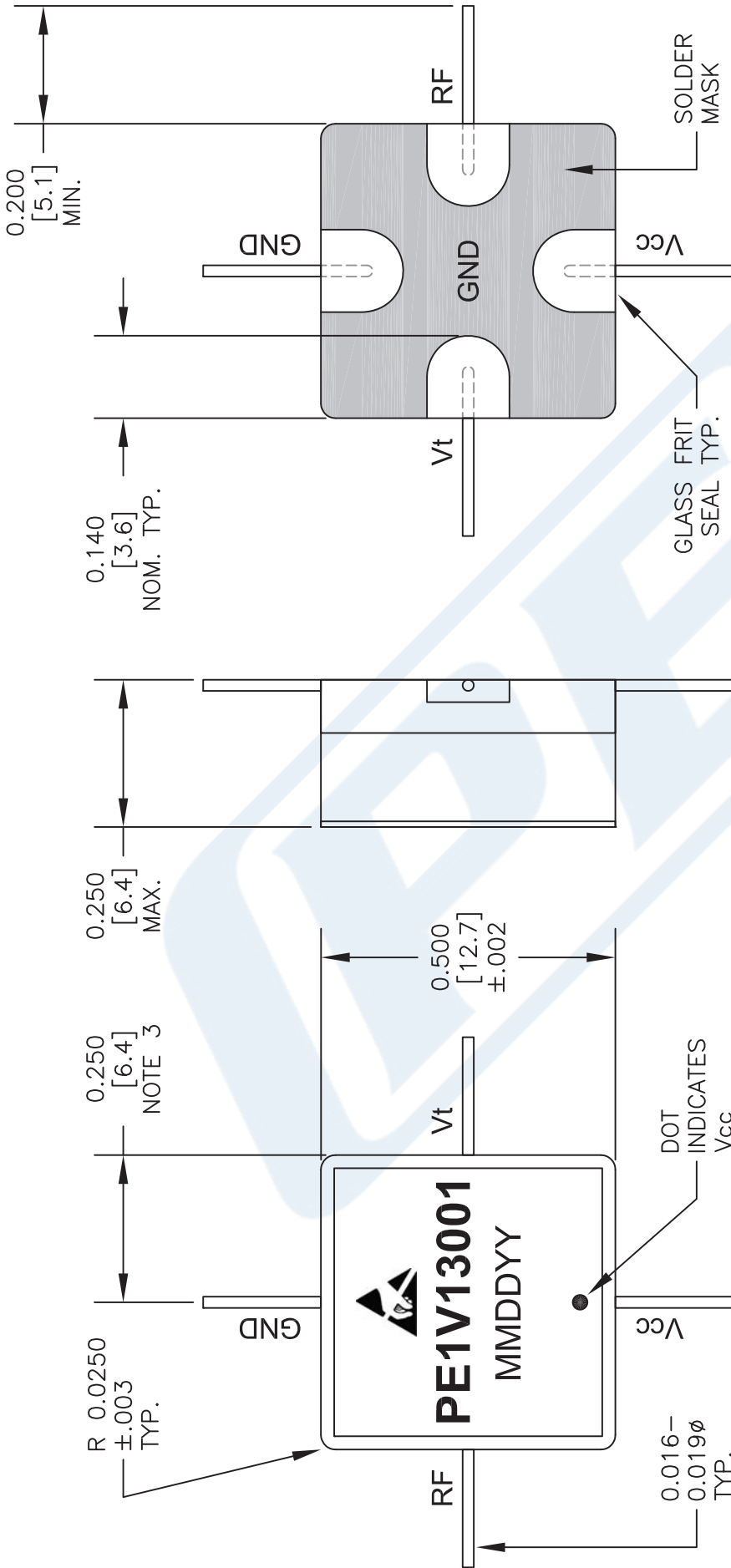

NOTES:

1. LEAD / BODY BASE MATERIAL IS KOVAR.
2. LEAD / BODY FINISH IS 50U" GOLD / NI.
3. MEASURED WITHIN .05" OF BODY.

DWG TITLE

PE1V13001

- NOTES:
1. UNLESS OTHERWISE SPECIFIED ALL DIMENSIONS ARE NOMINAL.
 2. ALL SPECIFICATIONS ARE SUBJECT TO CHANGE WITHOUT NOTICE AT ANY TIME.
 3. DIMENSIONS ARE IN INCHES [mm].

PE PASTERNAK®
 THE ENGINEER'S RF SOURCE
 Pasternack Enterprises, Inc.
 P.O. Box 16759 | Irvine | CA | 92623
 Phone: (949) 261-1920 | Fax: (949) 261-7451
 Website: www.pasternack.com | E-Mail: sales@pasternack.com

FSCM NO. 53919

CAD FILE 021116

SCALE N/A

SIZE A

2233

PE1V13001 CAD Drawing

0.5 inch Hermetic Surface Mount (SMT) Voltage Controlled Oscillator (VCO) From 18 MHz to 30 MHz With Phase Noise of -120 dBc/Hz

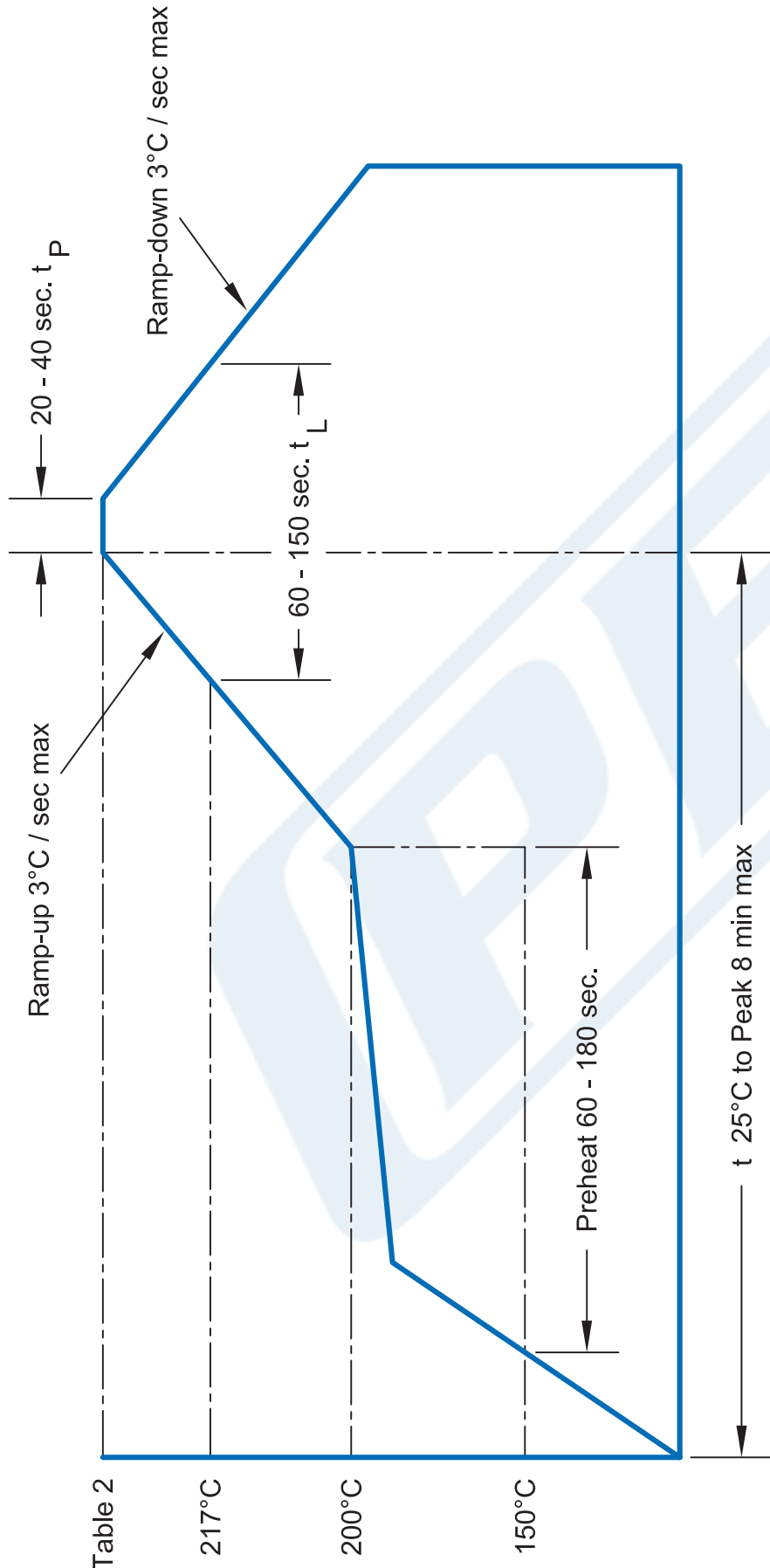

Table 2

Package re-flow temp	Pkg.	tp (°C)
	PE2V Series	260
	PE1V11 Series	245
	All Others	245

Table 1

Hand Soldering	Item	Condition
	Tip Temp. (max.)	260°
	Iron Power (max.)	20 W
	Time (max.)	3 Sec.
	Note.	Avoid excess pressure to castelations

NOTES:
 1. ALL VCO'S HAVE A MS RATING OF 1
 2. ALL PRODUCTS CONFORM TO JEDEC J-STD-020C FOR LEAD FREE PROCESSING.

NOTES:
 1. UNLESS OTHERWISE SPECIFIED ALL DIMENSIONS ARE NOMINAL.
 2. ALL SPECIFICATIONS ARE SUBJECT TO CHANGE WITHOUT NOTICE AT ANY TIME.
 3. DIMENSIONS ARE IN INCHES [mm].

DWG TITLE
PE1V13001

FSCM NO. 53919

CAD FILE 021116

SCALE N/A

SIZE A

2233

PE PASTERNAK®
 THE ENGINEERS' RF SOURCE
 Pasternack Enterprises, Inc.
 P.O. Box 16759 | Irvine | CA | 92623
 Phone: (949) 261-1920 | Fax: (949) 261-7451
 Website: www.pasternack.com | E-Mail: sales@pasternack.com