



SMA Male to SMA Male Cable 12 Inch Length Using PE-P195 Coax

RF Cable Assemblies Technical Data Sheet

PE3138-12

Configuration

- Connector 1: SMA Male
- Connector 2: SMA Male
- Cable Type: PE-P195

Features

- Triple Shielded
- FEP Jacket

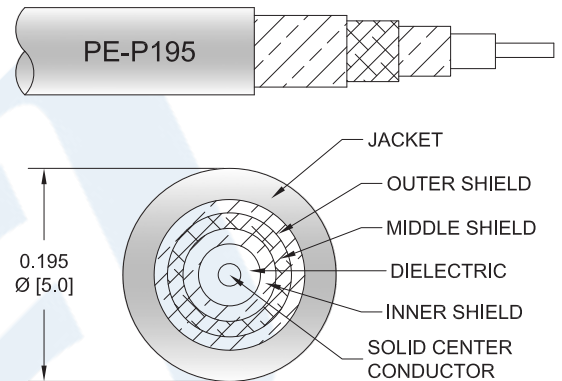

Applications

- General Purpose
- Laboratory Use

Description

Pasternack's PE3138-12 SMA male to SMA male 12 inch cable using PE-P195 coax is part of our full line of RF components available for same-day shipping. Pasternack's flexible RF cable assemblies are ideal for applications where tight bends and flexure are required. This Pasternack SMA to SMA cable assembly has a male to male gender configuration with 50 ohm flexible PE-P195 coax. The triple shielding of this Pasternack cable assembly provides excellent shielding effectiveness.

Custom versions of most RF cable assemblies can be built and shipped same day. Custom cable assembly lengths can be obtained by specifying the desired length on the web site at time of order or by contacting a sales representative. Other available RF cable assembly value added services include connector orientation or clocking, heat shrink booting and custom labeling. RF testing can also be performed to document the electrical performance of your cable assembly.

Electrical Specifications

Description	Minimum	Typical	Maximum	Units
Capacitance		29 [95.14]		pF/ft [pF/m]
Jacket Spark			2,000	Vrms

Mechanical Specifications

Cable Assembly

Length*	12 in [304.8 mm]
Diameter	0.312 in [7.92 mm]
Weight	0.071 lbs [32.21 g]

Click the following link (or enter part number in "SEARCH" on website) to obtain additional part information including price, inventory and certifications: [SMA Male to SMA Male Cable 12 Inch Length Using PE-P195 Coax PE3138-12](#)



SMA Male to SMA Male Cable 12 Inch Length Using PE-P195 Coax

RF Cable Assemblies Technical Data Sheet

PE3138-12

Cable

Cable Type	PE-P195
Impedance	50 Ohms
Inner Conductor Type	Solid
Inner Conductor Material and Plating	Copper Clad Steel, Silver
Dielectric Type	PTFE
Number of Shields	3
Shield Layer 1	Silver Plated Copper
Shield Layer 2	Aluminum Tape
Shield Layer 3	Silver Plated Copper Braid
Jacket Material	FEP, Tan
Jacket Diameter	0.195 in [4.95 mm]

Connectors

Description	Connector 1	Connector 2
Type	SMA Male	SMA Male
Impedance	50 Ohms	50 Ohms
Contact Material and Plating	Gold	Gold
Dielectric Type	PTFE	PTFE
Body Material and Plating	Brass, Nickel	Brass, Nickel
Coupling Nut Material and Plating	Brass, Nickel	Brass, Nickel
Hex Size	5/16 in	5/16 in
Torque	5 in-lbs [0.57 Nm]	5 in-lbs [0.57 Nm]

Mechanical Specification Notes:

*All cable assemblies have a length tolerance of 1.5% or $\pm 3/8$ ", whichever is greater.

Environmental Specifications

Temperature

Operating Range -55 to +165 deg C

Compliance Certifications (see [product page](#) for current document)

Plotted and Other Data

Notes:

- Values at 25°C, sea level.

Click the following link (or enter part number in "SEARCH" on website) to obtain additional part information including price, inventory and certifications: [SMA Male to SMA Male Cable 12 Inch Length Using PE-P195 Coax PE3138-12](#)



SMA Male to SMA Male Cable 12 Inch Length Using PE-P195 Coax

RF Cable Assemblies Technical Data Sheet

PE3138-12

How to Order

Part Number Configuration:

PE3138

- xx

uu

Unit of Measure:
cm = Centimeters
<blank> = Inches
Length
Base Number

Example: PE3138-12 = 12 inches long cable
PE3138-100cm = 100 cm long cable

SMA Male to SMA Male Cable 12 Inch Length Using PE-P195 Coax from Pasternack Enterprises has same day shipment for domestic and International orders. Our RF, microwave and millimeter wave products maintain a 99.4% availability and are part of the broadest selection in the industry.

Click the following link (or enter part number in "SEARCH" on website) to obtain additional part information including price, inventory and certifications: [SMA Male to SMA Male Cable 12 Inch Length Using PE-P195 Coax PE3138-12](https://www.pasternack.com/sma-male-sma-male-pe-p195-cable-assembly-pe3138-12-p.aspx)

URL: <https://www.pasternack.com/sma-male-sma-male-pe-p195-cable-assembly-pe3138-12-p.aspx>

The information contained in this document is accurate to the best of our knowledge and representative of the part described herein. It may be necessary to make modifications to the part and/or the documentation of the part, in order to implement improvements. Pasternack reserves the right to make such changes as required. Unless otherwise stated, all specifications are nominal. Pasternack does not make any representation or warranty regarding the suitability of the part described herein for any particular purpose, and Pasternack does not assume any liability arising out of the use of any part or documentation.

PE3138-12 CAD Drawing

SMA Male to SMA Male Cable 12 Inch Length Using PE-P195 Coax

Standard Lengths	
-12	12"
-24	24"
-36	36"
-48	48"
-60	60"
-XXX	Custom Length in Inches

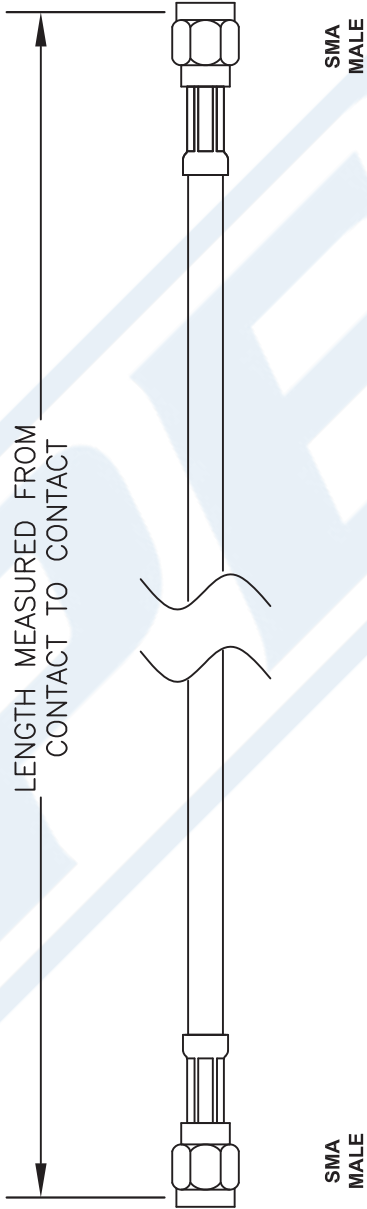

NOTES:
 1. UNLESS OTHERWISE SPECIFIED ALL DIMENSIONS ARE NOMINAL.
 2. ALL SPECIFICATIONS ARE SUBJECT TO CHANGE WITHOUT NOTICE AT ANY TIME.
 3. DIMENSIONS ARE IN INCHES [mm].
 4. LENGTH TOLERANCE IS $\pm 1.5\%$ OR $3/8"$, WHICHEVER IS GREATER.

DWG TITLE
PE3138-XX

PE PASTERNAK®
 Pasternack Enterprises, Inc.
 P.O. Box 16759 | Irvine | CA | 92623
 Phone: (949) 261-1920 | Fax: (949) 261-7451
 Website: www.pasternack.com | E-Mail: sales@pasternack.com

REV. B	FSCM NO. 53919	CAD FILE 050409	SCALE N/A	SIZE A	127
--------	----------------	-----------------	-----------	--------	-----