



N Female Bulkhead to MMCX Plug Right Angle Semi-Flexible Precision Cable 12 Inch Length Using PE-SR405FL Coax, RoHS

RF Cable Assemblies Technical Data Sheet

PE39450-12

Configuration

- Connector 1: N Female Bulkhead
- Connector 2: MMCX Plug Right Angle
- Cable Type: PE-SR405FL

Features

- Dimensionally and electrically the same as standard, solid outer conductor semi-rigid coax
- Cable may be formed by hand and does not require special tools to bend
- May be formed more than once without damaging the outer conductor
- High RF Shielding >100 dB
- 100% Hi-pot and continuity tested
- 100% VSWR tested to max frequency of assembly
- Standard and custom lengths ship the same day

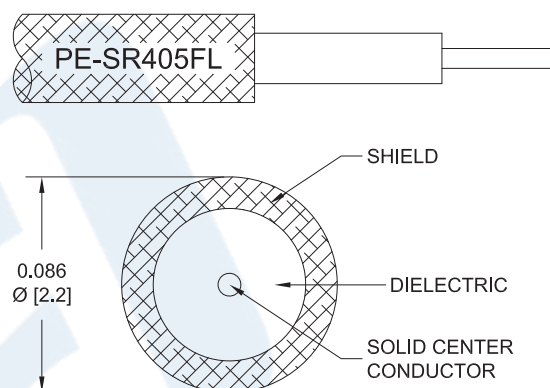

Description

Pasternack's formable cable assemblies are hand formable semi-rigid replacements that are an alternative to costly preformed assemblies. The formable semi-rigid cable alternatives are dimensionally and electrically similar to their semi-rigid counterpart and have a tinned-copper-braid outer shield that provides excellent RF shielding. The hand formable cable assemblies from Pasternack do not require special tooling to shape or reshape the assemblies and can replace standard semi-rigid versions. The assemblies are available with or without a FEP jacket and are RoHS compliant,

Electrical Specifications

Description	Minimum	Typical	Maximum	Units
Frequency Range	DC		6	GHz
VSWR			1.35:1	
Velocity of Propagation		69.5		%
RF Shielding	100			dB
Capacitance		29 [95.14]		pF/ft [pF/m]
Operating Voltage (AC)			170	Vrms

Specifications by Frequency

Description	F1	F2	F3	F4	F5	Units
Frequency	0.25	0.5	1	2.5	6	GHz
Insertion Loss (Typ.)	0.256	0.313	0.425	0.547	0.802	dB

Click the following link (or enter part number in "SEARCH" on website) to obtain additional part information including price, inventory and certifications: [N Female Bulkhead to MMCX Plug Right Angle Semi-Flexible Precision Cable 12 Inch Length Using PE-SR405FL Coax, RoHS PE39450-12](#)



N Female Bulkhead to MMCX Plug Right Angle Semi-Flexible Precision Cable 12 Inch Length Using PE-SR405FL Coax, RoHS

RF Cable Assemblies Technical Data Sheet

PE39450-12

Mechanical Specifications

Cable Assembly

Length	12 in [304.8 mm]
Diameter	0.866 in [22 mm]
Weight	0.104 lbs [47.17 g]

Cable

Cable Type	PE-SR405FL
Impedance	50 Ohms
Inner Conductor Type	Solid
Inner Conductor Material and Plating	Copper Clad Steel, Silver
Dielectric Type	PTFE
Number of Shields	1
Shield Layer 1	Tinned Copper Braid

Connectors

Description	Connector 1	Connector 2
Type	N Female Bulkhead	MMCX Plug Right Angle
Impedance	50 Ohms	50 Ohms
Contact Material and Plating	Phosphor Bronze, Gold	Phosphor Bronze, Gold
Dielectric Type	PTFE	PTFE
Body Material and Plating	Brass, Nickel	Brass, Gold

Environmental Specifications

Temperature

Operating Range	-65 to +125 deg C
-----------------	-------------------

Compliance Certifications (visit www.Pasternack.com for current document)

RoHS Compliant	Yes
REACH Compliant	12/17/2015

Plotted and Other Data

Notes:

- Values at 25°C, sea level.

Click the following link (or enter part number in "SEARCH" on website) to obtain additional part information including price, inventory and certifications: [N Female Bulkhead to MMCX Plug Right Angle Semi-Flexible Precision Cable 12 Inch Length Using PE-SR405FL Coax, RoHS PE39450-12](#)



N Female Bulkhead to MMCX Plug Right Angle Semi-Flexible Precision Cable 12 Inch Length Using PE-SR405FL Coax, RoHS

RF Cable Assemblies Technical Data Sheet

PE39450-12

How to Order

Part Number Configuration:

PE39450

- **xx**

uu

Unit of Measure:

cm = Centimeters

<blank> = Inches

Length

Base Number

Example: PE39450-12 = 12 inches long cable
PE39450-100cm = 100 cm long cable

N Female Bulkhead to MMCX Plug Right Angle Semi-Flexible Precision Cable 12 Inch Length Using PE-SR405FL Coax, RoHS from Pasternack Enterprises has same day shipment for domestic and International orders. Our RF, microwave and millimeter wave products maintain a 99% availability and are part of the broadest selection in the industry.

Click the following link (or enter part number in "SEARCH" on website) to obtain additional part information including price, inventory and certifications: [N Female Bulkhead to MMCX Plug Right Angle Semi-Flexible Precision Cable 12 Inch Length Using PE-SR405FL Coax, RoHS PE39450-12](http://www.pasternack.com/n-female-mmcx-plug-pe-sr405fl-cable-assembly-pe39450-12-p.aspx)

URL: <http://www.pasternack.com/n-female-mmcx-plug-pe-sr405fl-cable-assembly-pe39450-12-p.aspx>

The information contained in this document is accurate to the best of our knowledge and representative of the part described herein. It may be necessary to make modifications to the part and/or the documentation of the part, in order to implement improvements. Pasternack reserves the right to make such changes as required. Unless otherwise stated, all specifications are nominal. Pasternack does not make any representation or warranty regarding the suitability of the part described herein for any particular purpose, and Pasternack does not assume any liability arising out of the use of any part or documentation.

PE39450-12 CAD Drawing

N Female Bulkhead to MMCX Plug Right Angle Semi-Flexible Precision
Cable 12 Inch Length Using PE-SR405FL Coax, RoHS

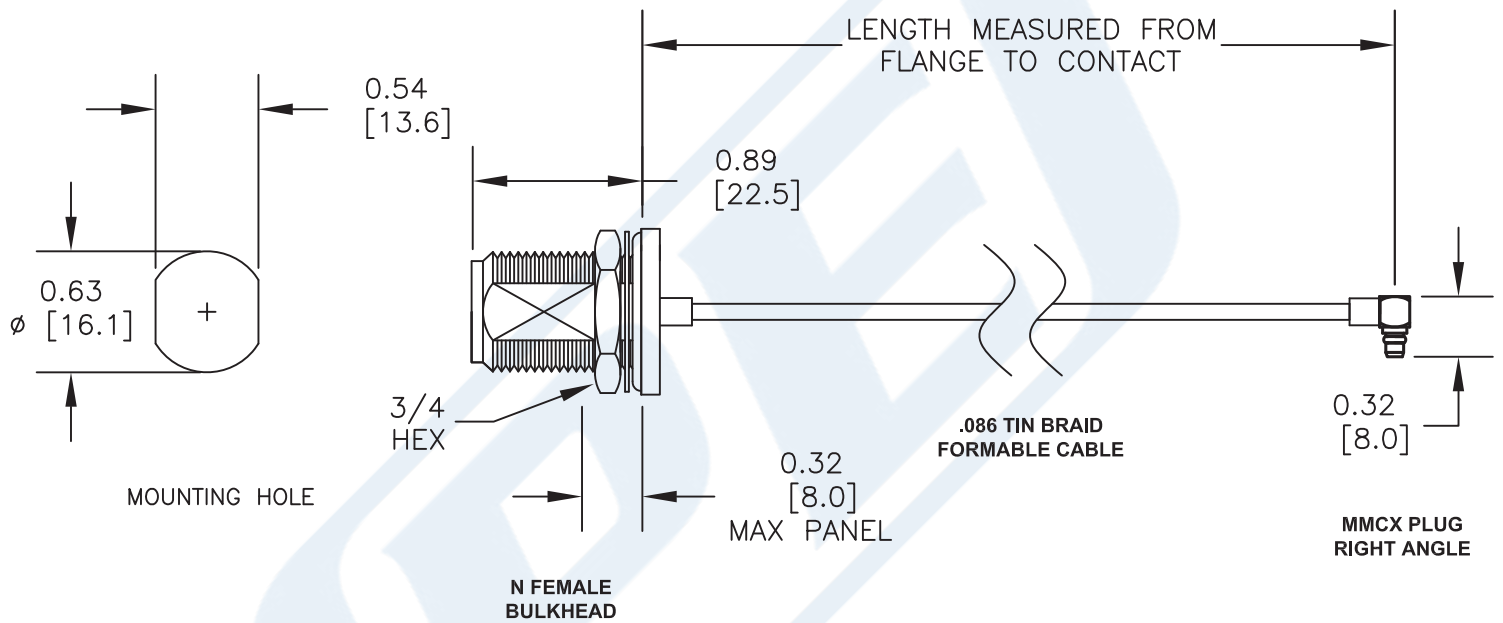

Note: This part is lead free.



Pasternack Enterprises, Inc.
P.O. Box 16759 | Irvine | CA | 92623

Phone: (949) 261-1920 | Fax: (949) 261-7451

Website: www.pasternack.com | E-Mail: sales@pasternack.com

NOTES:

1. UNLESS OTHERWISE SPECIFIED ALL DIMENSIONS ARE NOMINAL.
2. ALL SPECIFICATIONS ARE SUBJECT TO CHANGE WITHOUT NOTICE AT ANY TIME.
3. DIMENSIONS ARE IN INCHES [mm].
4. LENGTH TOLERANCE IS $\pm 1.5\%$ OR $3/8"$, WHICHEVER IS GREATER.

DWG TITLE

PE39450

FSCM NO. 53919

CAD FILE

012115

SCALE N/A

SIZE A

2233