



SMA Male Right Angle to TNC Female Bulkhead Semi-Flexible Precision Cable 9 Inch Length Using PE-SR402FL Coax, RoHS

TECHNICAL DATA SHEET PE39484-9

Pasternack's formable cable assemblies are hand formable semi-rigid replacements that are an alternative to costly preformed assemblies. The formable semi-rigid cable alternatives are dimensionally and electrically similar to their semi-rigid counterpart and have a tinned-copper-braid outer shield that provides excellent RF shielding. The hand formable cable assemblies from Pasternack do not require special tooling to shape or reshape the assemblies and can replace standard semi-rigid versions. The assemblies are available with or without a FEP jacket and are RoHS compliant,

Features

- Dimensionally and electrically the same as standard, solid outer conductor semi-rigid coax
- Cable may be formed by hand and does not require special tools to bend
- May be formed more than once without damaging the outer conductor
- High RF Shielding >100 dB
- 100% Hi-pot and continuity tested
- 100% VSWR tested to max frequency of assembly
- Standard and custom lengths ship the same day

Configuration

Connector 1	SMA Male Right Angle
Connector 2	TNC Female Bulkhead
Cable Type	PE-SR402FL

Electrical Specifications

Frequency Range	DC to 6 GHz
Impedance	50 Ohms
Velocity of Propagation	69.5 %
Group Delay	1.43 ns/ft [4.69 ns/m]
RF Shielding	100 dB

Performance by Frequency

Frequency 1	
Frequency	250 MHz
Insertion Loss	0.222 dB
Frequency 2	
Frequency	500 MHz
Insertion Loss	0.245 dB
Frequency 3	
Frequency	1000 MHz
Insertion Loss	0.289 dB
Frequency 4	
Frequency	2.5 GHz
Insertion Loss	0.334 dB
Frequency 5	
Frequency	6 GHz

Click the following link (or enter part number in "SEARCH" on website) to obtain additional part information including price, inventory and certifications: [SMA Male Right Angle to TNC Female Bulkhead Semi-Flexible Precision Cable 9 Inch Length Using PE-SR402FL Coax, RoHS PE39484-9](#)



SMA Male Right Angle to TNC Female Bulkhead Semi-Flexible Precision Cable 9 Inch Length Using PE-SR402FL Coax, RoHS

TECHNICAL DATA SHEET

PE39484-9

Insertion Loss 0.431 dB

Mechanical Specifications

Size

Length 9 in [228.6 mm]
Diameter 0.69 in [17.53 mm]
One Time Minimum Bend Radius 0.315 in [8 mm]
Repeated Minimum Bend Radius 1.57 in [39.88 mm]

Cable

Cable Type PE-SR402FL
Inner Conductor Type Solid
Cable Inner Conductor Copper, Silver
No of Shields 1
Dielectric Type PTFE

Connector 1

Type SMA Male Right Angle
Configuration Right Angle
Inner Conductor Material and Plating Brass, Gold
Coupling Nut Material and Plating Passivated Stainless Steel
Hex Size 5/16 in.
Torque 8 in-lbs [0.9 Nm]
Body Material and Plating Brass, Gold
Dielectric Type PTFE

Connector 2

Type TNC Female Bulkhead
Configuration Straight
Mount Method Bulkhead
Inner Conductor Material and Plating Beryllium Copper, Gold
Body Material and Plating Brass, Nickel
Dielectric Type PTFE

Compliance Certifications (visit www.Pasternack.com for current document)

RoHS Compliant Yes
REACH Compliant 06/18/2012

Plotted and Other Data

Notes:
• Values at +25 °C, sea level

Click the following link (or enter part number in "SEARCH" on website) to obtain additional part information including price, inventory and certifications: [SMA Male Right Angle to TNC Female Bulkhead Semi-Flexible Precision Cable 9 Inch Length Using PE-SR402FL Coax, RoHS PE39484-9](#)



SMA Male Right Angle to TNC Female Bulkhead Semi-Flexible Precision Cable 9 Inch Length Using PE-SR402FL Coax, RoHS

TECHNICAL DATA SHEET

PE39484-9

How to Order

Part Number Configuration:

PE39484-9

- **xx**

uu

Unit of Measure:

cm = Centimeters

<blank> = Inches

Length

Base Number

Example: PE39484-9-12 = 12 inches long cable
PE39484-9-100cm = 100 cm long cable

SMA Male Right Angle to TNC Female Bulkhead Semi-Flexible Precision Cable 9 Inch Length Using PE-SR402FL Coax, RoHS from Pasternack Enterprises has same day shipment for domestic and International orders. Our RF, microwave and millimeter wave products maintain a 99% availability and are part of the broadest selection in the industry.

Click the following link (or enter part number in "SEARCH" on website) to obtain additional part information including price, inventory and certifications: [SMA Male Right Angle to TNC Female Bulkhead Semi-Flexible Precision Cable 9 Inch Length Using PE-SR402FL Coax, RoHS PE39484-9](http://www.pasternack.com/sma-male-tnc-female-pe-sr402fl-cable-assembly-pe39484-9-p.aspx)

URL: <http://www.pasternack.com/sma-male-tnc-female-pe-sr402fl-cable-assembly-pe39484-9-p.aspx>

The information contained in this document is accurate to the best of our knowledge and representative of the part described herein. It may be necessary to make modifications to the part and/or the documentation of the part, in order to implement improvements. Pasternack reserves the right to make such changes as required. Unless otherwise stated, all specifications are nominal. Pasternack does not make any representation or warranty regarding the suitability of the part described herein for any particular purpose, and Pasternack does not assume any liability arising out of the use of any part or documentation.

PE39484-9 CAD Drawing

SMA Male Right Angle to TNC Female Bulkhead Semi-Flexible
Precision Cable 9 Inch Length Using PE-SR402FL Coax, RoHS

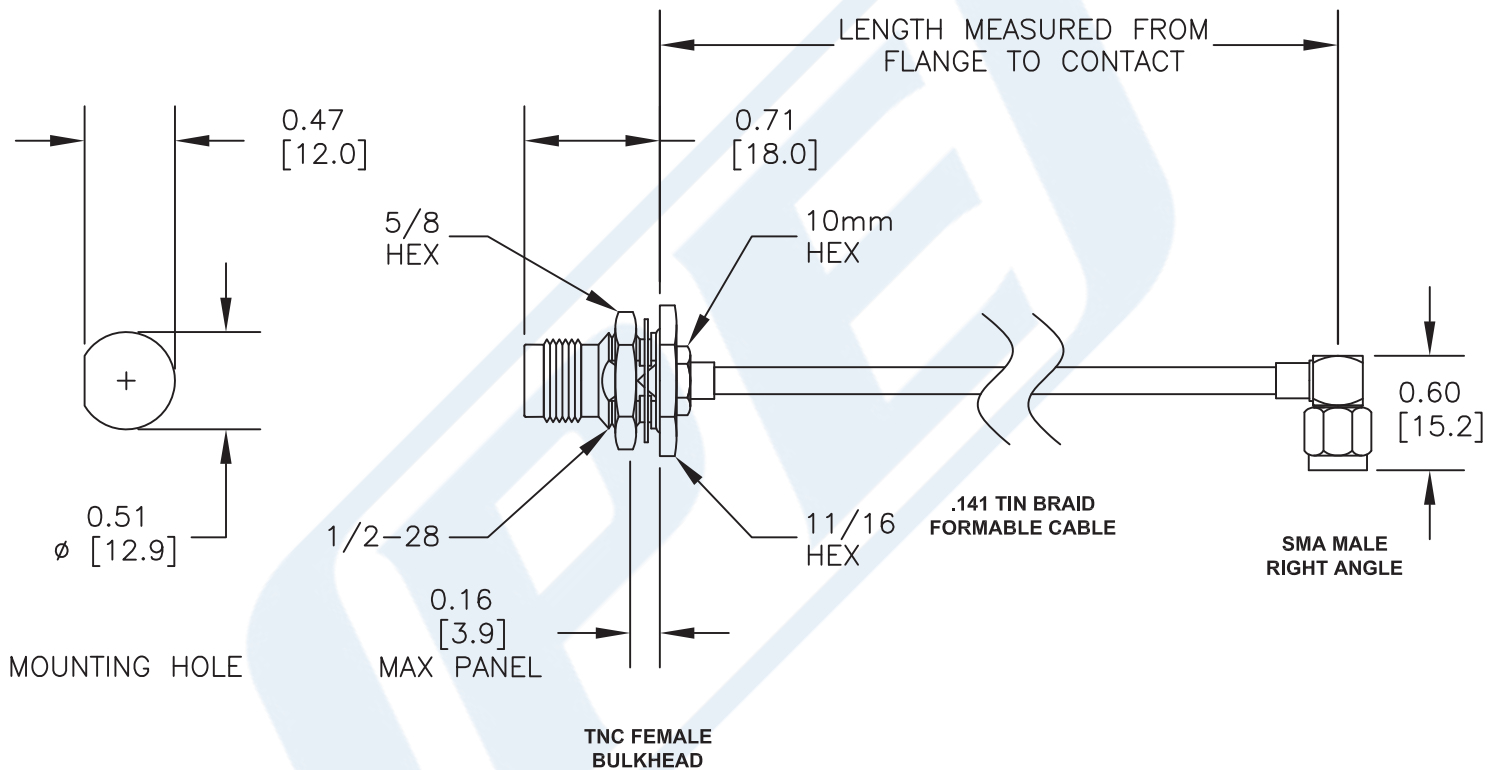

Note: This part is lead free.



Pasternack Enterprises, Inc.
P.O. Box 16759 | Irvine | CA | 92623

Phone: (949) 261-1920 | Fax: (949) 261-7451

Website: www.pasternack.com | E-Mail: sales@pasternack.com

NOTES:

1. UNLESS OTHERWISE SPECIFIED ALL DIMENSIONS ARE NOMINAL.
2. ALL SPECIFICATIONS ARE SUBJECT TO CHANGE WITHOUT NOTICE AT ANY TIME.
3. DIMENSIONS ARE IN INCHES [mm].
4. LENGTH TOLERANCE IS $\pm 1.5\%$ OR $3/8"$, WHICHEVER IS GREATER.

DWG TITLE

PE39484

FSCM NO. 53919

CAD FILE

012215

SCALE N/A

SIZE A

2233