



SMA Female to SMA Male Right Angle Low Loss Cable 200 cm Length Using LMR-100 Coax

RF Cable Assemblies Technical Data Sheet

PE3W10002-200CM

Configuration

- Connector 1: SMA Female
- Connector 2: SMA Male Right Angle
- Cable Type: LMR-100A

Features

- Max Frequency 5.8 GHz
- Shielding Effectivity > 90 dB
- 66% Phase Velocity
- Double Shielded
- PVC Jacket

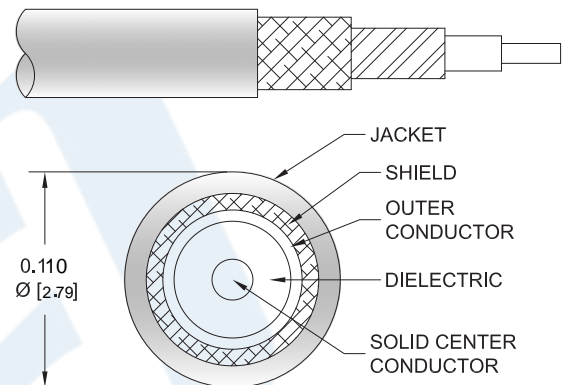

Applications

- General Purpose
- Laboratory Use

Description

Pasternack's PE3W10002-200CM SMA female to SMA male right angle 200 cm cable using LMR-100 coax is part of our full line of RF components available for same-day shipping. Pasternack's flexible RF cable assemblies are ideal for applications where tight bends and flexure are required. This Pasternack SMA to SMA cable assembly has a female to male gender configuration with 50 ohm flexible LMR-100A coax. The PE3W10002-200CM SMA female to SMA male cable assembly operates to 5.8 GHz. The right angle SMA interface on the LMR-100A cable allows for easier connections in tight spaces. The double shielding of this Pasternack cable assembly provides excellent shielding effectiveness of better than 90 dB.

Custom versions of most RF cable assemblies can be built and shipped same day. Custom cable assembly lengths can be obtained by specifying the desired length on the web site at time of order or by contacting a sales representative. Other available RF cable assembly value added services include connector orientation or clocking, heat shrink booting and custom labeling. RF testing can also be performed to document the electrical performance of your cable assembly.

Click the following link (or enter part number in "SEARCH" on website) to obtain additional part information including price, inventory and certifications: [SMA Female to SMA Male Right Angle Low Loss Cable 200 cm Length Using LMR-100 Coax PE3W10002-200CM](#)



SMA Female to SMA Male Right Angle Low Loss Cable 200 cm Length Using LMR-100 Coax

RF Cable Assemblies Technical Data Sheet

PE3W10002-200CM

Electrical Specifications

Description	Minimum	Typical	Maximum	Units
Frequency Range	DC		5.8	GHz
VSWR			1.45:1	
Velocity of Propagation		66		%
RF Shielding	90			dB
Group Delay		1.54 [5.05]		ns/ft [ns/m]
Capacitance		30.8 [101.05]		pF/ft [pF/m]
Inductance		0.077 [0.25]		uH/ft [uH/m]
DC Resistance Inner Conductor		81 [265.75]		Ω /1000ft [Ω /Km]
DC Resistance Outer Conductor		9.5 [31.17]		Ω /1000ft [Ω /Km]
Jacket Spark			2,000	Vrms

Specifications by Frequency

Description	F1	F2	F3	F4	F5	Units
Frequency	0.25	0.5	1	2.5	5.8	GHz
Insertion Loss (Typ.)	1.09	1.42	1.87	2.92	4.5	dB

Electrical Specification Notes:

The Insertion Loss data above is based on the performance specifications of the coax cable and connectors used in this assembly. The Insertion Loss includes an estimated insertion loss of 0.1 dB for the straight connector and 0.2 dB for the right angle connector.

Mechanical Specifications

Cable Assembly

Length*	78.74 in [200 cm]
Diameter	0.689 in [17.5 mm]

Cable

Cable Type	LMR-100A
Impedance	50 Ohms
Inner Conductor Type	Solid
Inner Conductor Material and Plating	Copper Clad Steel
Dielectric Type	PE
Number of Shields	2
Shield Layer 1	Aluminum Tape
Shield Layer 2	Tinned Copper Braid

Click the following link (or enter part number in "SEARCH" on website) to obtain additional part information including price, inventory and certifications: [SMA Female to SMA Male Right Angle Low Loss Cable 200 cm Length Using LMR-100 Coax PE3W10002-200CM](#)



SMA Female to SMA Male Right Angle Low Loss
Cable 200 cm Length Using LMR-100 Coax

RF Cable Assemblies Technical Data Sheet

PE3W10002-200CM

Jacket Material	PVC, Black
Jacket Diameter	0.11 in [2.79 mm]
One Time Minimum Bend Radius	0.25 in [6.35 mm]
Repeated Minimum Bend Radius	1 in [25.4 mm]
Bending Moment	0.1 lbs-ft [0.14 N-m]
Flat Plate Crush	10 lbs/in [0.18 Kg/mm]
Tensile Strength	15 lbs [6.8 Kg]

Connectors

Description	Connector 1	Connector 2
Type	SMA Female	SMA Male Right Angle
Specification	MIL-STD-348A	
Impedance	50 Ohms	50 Ohms
Contact Material and Plating	Beryllium Copper, Gold	Brass, Gold
Contact Plating Specification	50µ in. minimum	
Dielectric Type	Teflon	Teflon
Outer Conductor Material and Plating	Brass, Gold	
Outer Conductor Plating Specification	3µ in. minimum	
Body Material and Plating	Brass, Gold	Brass, Gold
Body Plating Specification	3µ in. minimum	
Coupling Nut Material and Plating		Brass, Gold
Hex Size		5/16 in
Torque		5 in-lbs [0.57 Nm]

Compliance Certifications (see [product page](#) for current document)

Plotted and Other Data

Notes:

Click the following link (or enter part number in "SEARCH" on website) to obtain additional part information including price, inventory and certifications: [SMA Female to SMA Male Right Angle Low Loss Cable 200 cm Length Using LMR-100 Coax PE3W10002-200CM](#)



SMA Female to SMA Male Right Angle Low Loss
Cable 200 cm Length Using LMR-100 Coax

RF Cable Assemblies Technical Data Sheet

PE3W10002-200CM

How to Order

Part Number Configuration:

PE3W10002

- **xx**

uu

Unit of Measure:
cm = Centimeters
<blank> = Inches
Length
Base Number

Example: PE3W10002-12 = 12 inches long cable
PE3W10002-100cm = 100 cm long cable

SMA Female to SMA Male Right Angle Low Loss Cable 200 cm Length Using LMR-100 Coax from Pasternack Enterprises has same day shipment for domestic and International orders. Our RF, microwave and millimeter wave products maintain a 99.4% availability and are part of the broadest selection in the industry.

Click the following link (or enter part number in "SEARCH" on website) to obtain additional part information including price, inventory and certifications: [SMA Female to SMA Male Right Angle Low Loss Cable 200 cm Length Using LMR-100 Coax PE3W10002-200CM](https://www.pasternack.com/sma-female-sma-male-lmr100-cable-assembly-pe3w10002-200cm-p.aspx)

URL: <https://www.pasternack.com/sma-female-sma-male-lmr100-cable-assembly-pe3w10002-200cm-p.aspx>

The information contained in this document is accurate to the best of our knowledge and representative of the part described herein. It may be necessary to make modifications to the part and/or the documentation of the part, in order to implement improvements. Pasternack reserves the right to make such changes as required. Unless otherwise stated, all specifications are nominal. Pasternack does not make any representation or warranty regarding the suitability of the part described herein for any particular purpose, and Pasternack does not assume any liability arising out of the use of any part or documentation.

PE3W10002-200CM CAD Drawing

SMA Female to SMA Male Right Angle Low Loss Cable

200 cm Length Using LMR-100 Coax

REVISIONS		
REV.	DESCRIPTION	DATE
A	INITIAL RELEASE	10/15/2020
		APPROVED S. ELLIS

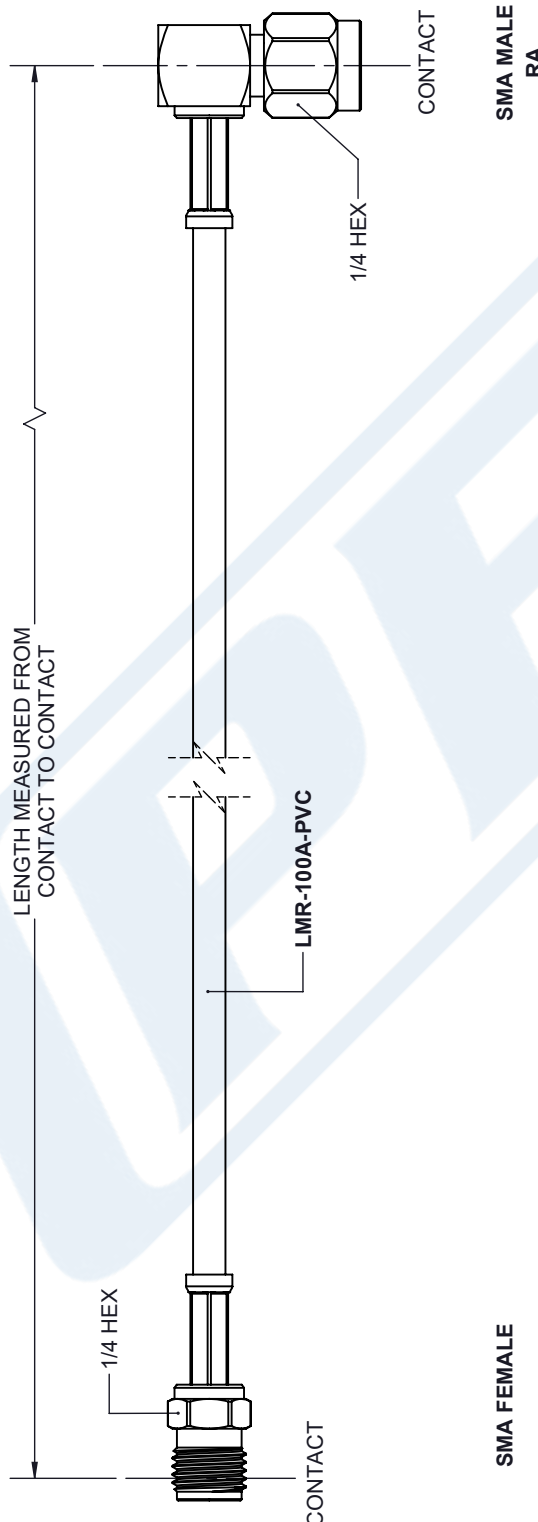

<p>UNLESS OTHERWISE SPECIFIED LEADING DIMENSIONS ARE INCHES DIMENSIONS IN [] ARE MILLIMETERS</p> <p>TOLERANCES:</p> <p>.X = ±.2 [.008] FRACTIONS ± 1/32 .XX = ±.02 [.51] ANGLES ± 1° .XXX = ±.005 [.13]</p> <p>CABLE LENGTH (L), TOLERANCES:</p> <p>L ≤ 12 [305] = +1 [25] / -0 12 [305] < L ≤ 60 [1524] = +2 [51] / -0 60 [1524] < L ≤ 120 [3048] = +4 [102] / -0 120 [3048] < L ≤ 300 [7620] = +6 [152] / -0 300 [7620] < L = +5% / -0</p> <p>ALL DIMENSIONS SHOWN ARE FOR REFERENCE ONLY.</p>	<p>THIRD-ANGLE PROJECTION</p> <p>THE INFORMATION AND DESIGN IN THIS DOCUMENT IS THE PROPERTY OF PASTERNAK CORPORATION ALL RIGHTS RESERVED.</p> <p>SHEET 1 OF 1</p> <p>SCALE N/A</p>	<p>PE PASTERNAK an INFINITE brand</p> <p>Pasternack Enterprises, Inc. P. O. Box 16759, Irvine, CA 92623. Phone: 1.949.261.1920 1.866.727.8376 Fax: 1.949.261.7451 Website: www.pasternack.com E-mail: sales@pasternack.com</p> <p>SIZE A CAGE CODE 53919 DRAWN BY K.DANG ITEM NO. PE3W10002 REV A</p>
---	--	---

THESE COMMODITIES, TECHNOLOGY OR SOFTWARE WERE EXPORTED FROM THE UNITED STATES IN ACCORDANCE WITH THE EXPORT ADMINISTRATION REGULATIONS. DIVERSION CONTRARY TO U.S. LAW PROHIBITED.