



WR-112 Waveguide Electromechanical Relay
 SPDT Latching Switch, X Band 10 GHz Max. Freq.,
 7,000 Watts, UG-51/U Square Cover, 28V

Waveguide Electromechanical Relay Switches Technical

PEWGS6020

Features

- 7.05 to 10 GHz SPDT Waveguide Switch
- Optional DPDT Configuration
- WR-112 Waveguide with O-Rings
- Insertion Loss: 0.05 dB max
- Isolation: 80 dB min
- +28 Vdc Nominal Voltage
- Input Power Rating up to 7 kW CW max
- Latching Self Cut Off Actuator
- Position Indicator and Manual Override Access
- Fully Weatherized Package
- Quick Connect Circular DC Connector with Mate
- -40°C to +85°C Operating Temperature

Applications

- Electronic Warfare
- Electronic Countermeasures
- Microwave Radio
- VSAT
- Radar
- Space Systems
- Test Instrumentation
- Research and Development

Description

The PEWGS6020 electromechanical WR-112 waveguide switch operates across a wide frequency range from 7.05 GHz to 10 GHz and is configured for single pole double throw (SPDT) operation. A shorting plate on port 3 can be removed for optional double pole double throw (DPDT) operation. This innovative design features a latching Self Cut Off actuator and patented motor drive with arc suppression. The motor drive housing supports a viewable position indicator window and a cover that can be removed for manual override access.

Impressive performance includes 0.02 dB typ insertion loss, 85 dB typ Isolation, 1.07:1 typ VSWR, and an operating life of 250K cycles minimum. The design operates across a temperature range of -40°C to +85°C, requires +28Vdc nominal bias voltage, and has an input power rating of up to 7 kW CW maximum. The waveguide ports have Grooved UG-51/U Square Cover Flanges (O-Rings included) for pressurized operation. The rugged package design is fully weatherized for up to 100% humidity exposure and supports a quick connect circular 6 pin MIL-SPEC DC bias connector with mate included.

Electrical Specifications

Switch Type	SPDT
Actuator Type	Latching
Switching Sequence	Break Before Make
Actuator Options	Self Cut Off, Window Indicator, Manual Override
Polarity	Negative Common

Description	Minimum	Typical	Maximum	Units
Frequency Range	7.05		10	GHz
Impedance		50		Ohms
Operating Voltage	21	28	32	Volts
Actuating Current @ 28 Volts		212	243	mA
VSWR		1.07:1	1.1:1	
Insertion Loss		0.02	0.05	dB
Isolation	80	85		dB
Switching Time		76	80	ms
Input Power (CW)			7	KWatts

Click the following link (or enter part number in "SEARCH" on website) to obtain additional part information including price, inventory and certifications: [WR-112 Waveguide Electromechanical Relay SPDT Latching Switch, X Band 10 GHz Max. Freq., 7,000 Watts, UG-51/U Square Cover, 28V PEWGS6020](#)



WR-112 Waveguide Electromechanical Relay
SPDT Latching Switch, X Band 10 GHz Max. Freq.,
7,000 Watts, UG-51/U Square Cover, 28V

Waveguide Electromechanical Relay Switches Technical

PEWGS6020

Input Power (Peak) 10% Duty Cycle	202	KWatts
-----------------------------------	-----	--------

Mechanical Specifications

Size

Length	5.2 in [132.08 mm]
Width/Diameter	2.25 in [57.15 mm]
Height	2.25 in [57.15 mm]
Weight	1.577 lbs [715.32 g]

Operating Life (Cold Switching)	250,000 Cycles
Operating Pressure	30 psig

Configuration

Waveguide Size	WR-112
Flange Type	Square Cover
Flange Designation	UG-51/U
Body Material and Plating	Aluminum, Chem Film
Body Plating Specification	MIL-DTL-5541 Type II Class 3

Mechanical Specification Notes:
Production Burn-In IAW MIL-DTL-55041 1500 cycles

Environmental Specifications

Temperature

Operating Range	-40 to +85 deg C
Storage Range	-55 to +100 deg C

Ingress Protection (IP) Rating	IP67
Humidity	0-100%, Fully Weatherized
ESD Sensitivity	ESD Sensitive Material, Transport material in Approved ESD bags. Handle in approved ESD Workstation.



Compliance Certifications (see [product page](#) for current document)

Plotted and Other Data

Notes:

Click the following link (or enter part number in "SEARCH" on website) to obtain additional part information including price, inventory and certifications: [WR-112 Waveguide Electromechanical Relay SPDT Latching Switch, X Band 10 GHz Max. Freq., 7,000 Watts, UG-51/U Square Cover, 28V PEWGS6020](#)



WR-112 Waveguide Electromechanical Relay
SPDT Latching Switch, X Band 10 GHz Max. Freq.,
7,000 Watts, UG-51/U Square Cover, 28V

Waveguide Electromechanical Relay Switches Technical

PEWGS6020

Typical Performance Data

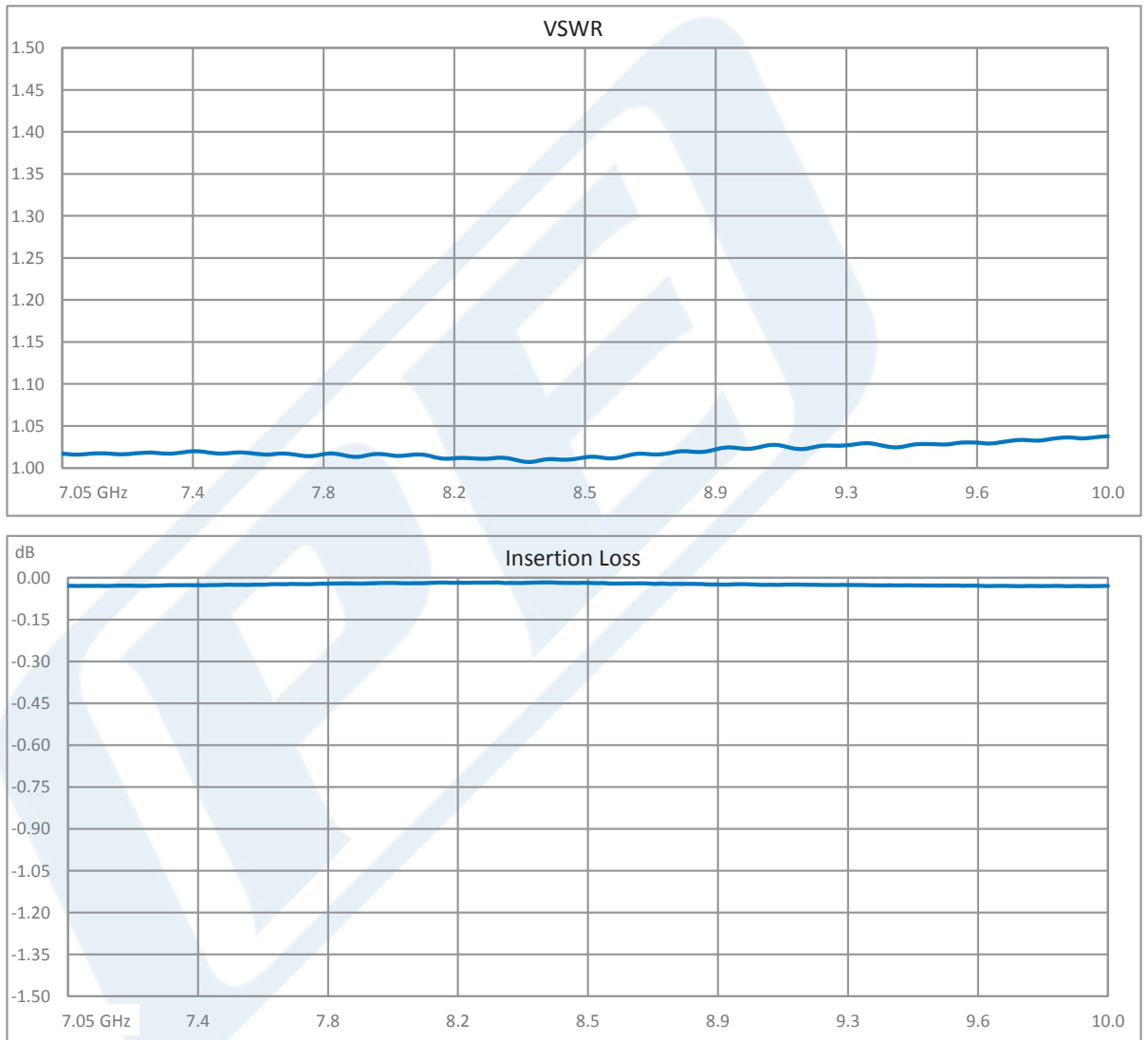

Click the following link (or enter part number in "SEARCH" on website) to obtain additional part information including price, inventory and certifications: [WR-112 Waveguide Electromechanical Relay SPDT Latching Switch, X Band 10 GHz Max. Freq., 7,000 Watts, UG-51/U Square Cover, 28V PEWGS6020](#)



WR-112 Waveguide Electromechanical Relay
SPDT Latching Switch, X Band 10 GHz Max. Freq.,
7,000 Watts, UG-51/U Square Cover, 28V

Waveguide Electromechanical Relay Switches Technical

PEWGS6020

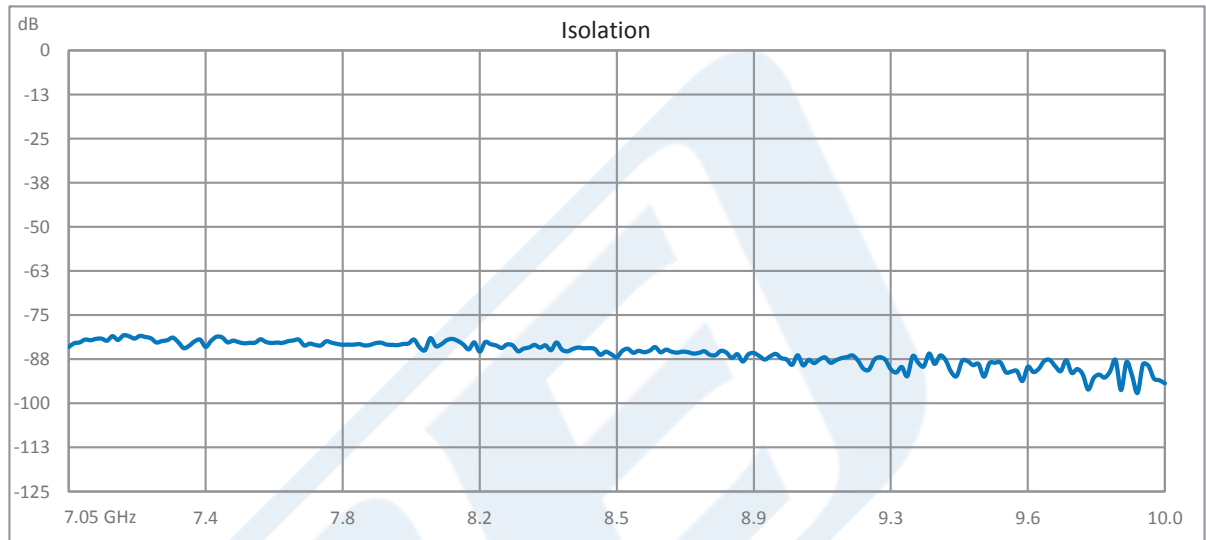

WR-112 Waveguide Electromechanical Relay SPDT Latching Switch, X Band 10 GHz Max. Freq., 7,000 Watts, UG-51/U Square Cover, 28V from Pasternack Enterprises has same day shipment for domestic and International orders. Our RF, microwave and millimeter wave products maintain a 99.4% availability and are part of the broadest selection in the industry.

Click the following link (or enter part number in "SEARCH" on website) to obtain additional part information including price, inventory and certifications: [WR-112 Waveguide Electromechanical Relay SPDT Latching Switch, X Band 10 GHz Max. Freq., 7,000 Watts, UG-51/U Square Cover, 28V PEWGS6020](https://www.pasternack.com/wr-112-waveguide-electromechanical-relay-spdt-latching-switch-10-ghz-pewgs6020-p.aspx)

URL: <https://www.pasternack.com/wr-112-waveguide-electromechanical-relay-spdt-latching-switch-10-ghz-pewgs6020-p.aspx>

The information contained in this document is accurate to the best of our knowledge and representative of the part described herein. It may be necessary to make modifications to the part and/or the documentation of the part, in order to implement improvements. Pasternack reserves the right to make such changes as required. Unless otherwise stated, all specifications are nominal. Pasternack does not make any representation or warranty regarding the suitability of the part described herein for any particular purpose, and Pasternack does not assume any liability arising out of the use of any part or documentation.

PEWGS6020 CAD Drawing

WR-112 Waveguide Electromechanical Relay SPDT Latching Switch, X
Band 10 GHz Max. Freq., 7,000 Watts, UG-51/U Square Cover, 28V

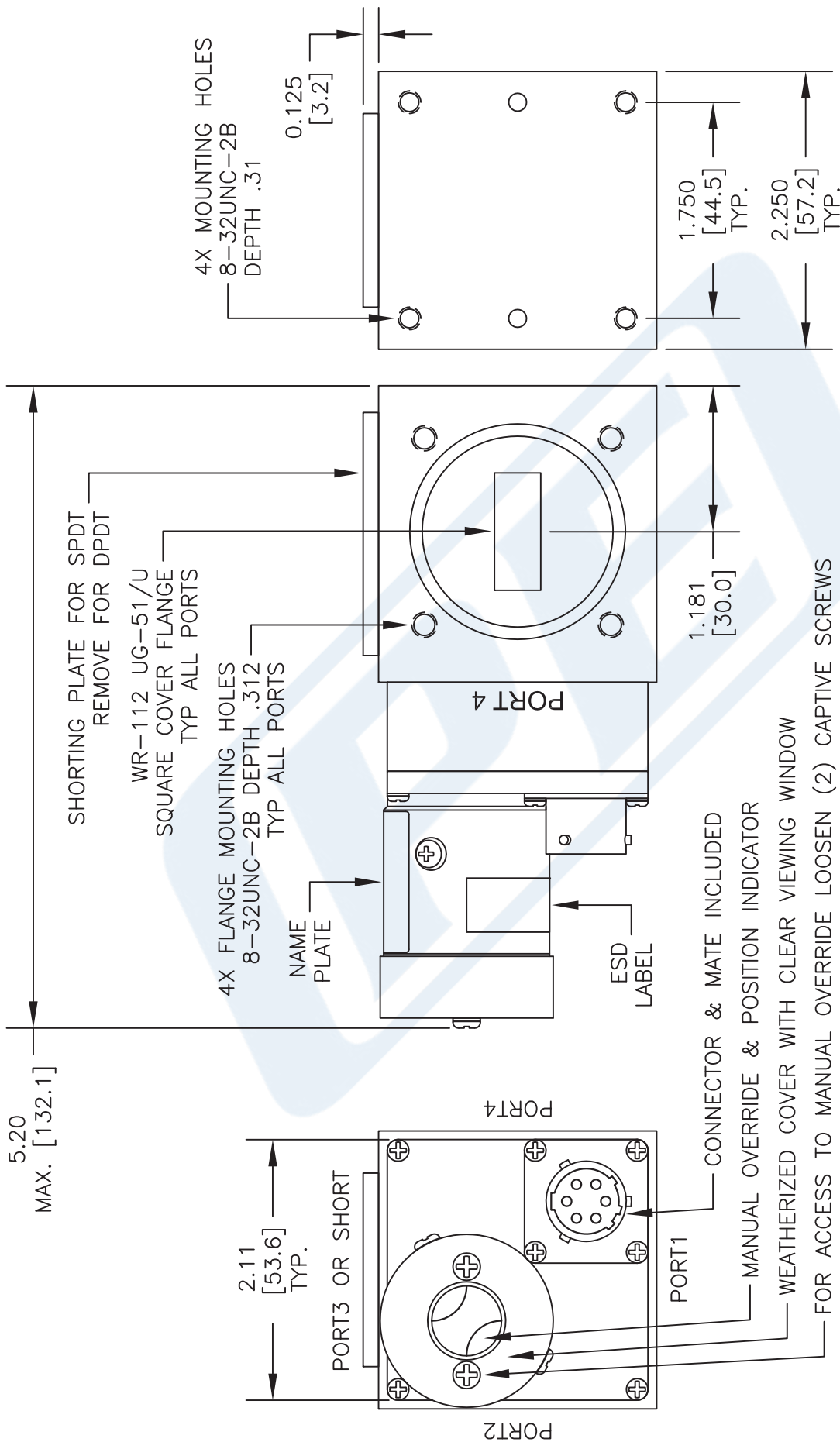

DWG TITLE

PEWGS6020

NOTES:
1. UNLESS OTHERWISE SPECIFIED ALL DIMENSIONS ARE NOMINAL.
2. ALL SPECIFICATIONS ARE SUBJECT TO CHANGE WITHOUT NOTICE AT ANY TIME.
3. DIMENSIONS ARE IN INCHES [mm].

PE PASTERNAK
THE ENGINEER'S RF SOURCE
Pasternack Enterprises, Inc.
P.O. Box 16759 | Irvine | CA | 92623
Phone: (949) 261-1920 | Fax: (949) 261-7451
Website: www.pasternack.com | E-Mail: sales@pasternack.com

CAGE CODE 53919

CAD FILE 013017

SCALE N/A

SIZE A

2233

PEWGS6020 CAD Drawing

WR-112 Waveguide Electromechanical Relay SPDT Latching Switch, X
Band 10 GHz Max. Freq., 7,000 Watts, UG-51/U Square Cover, 28V

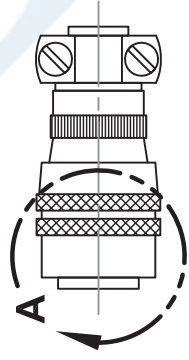
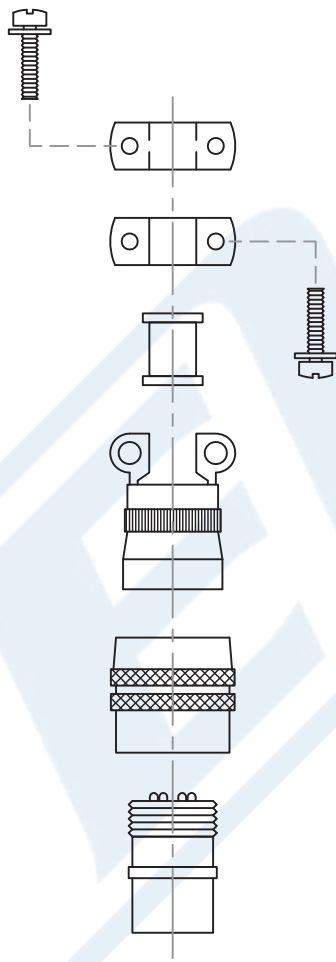
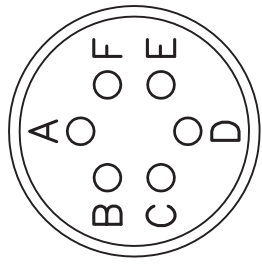
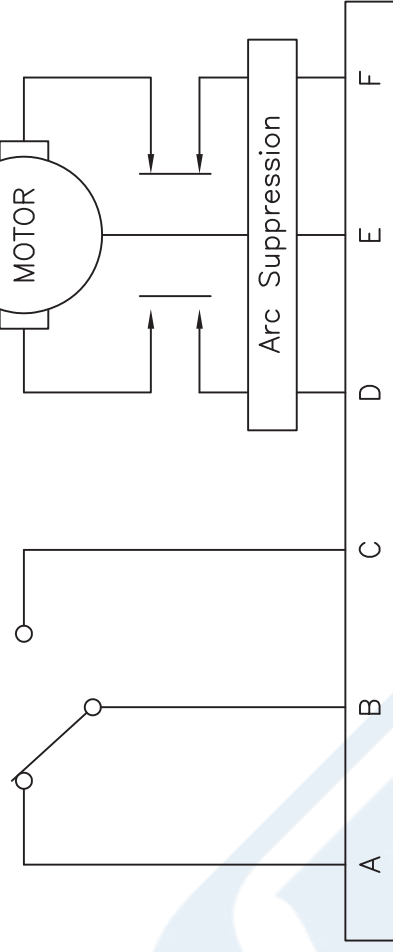
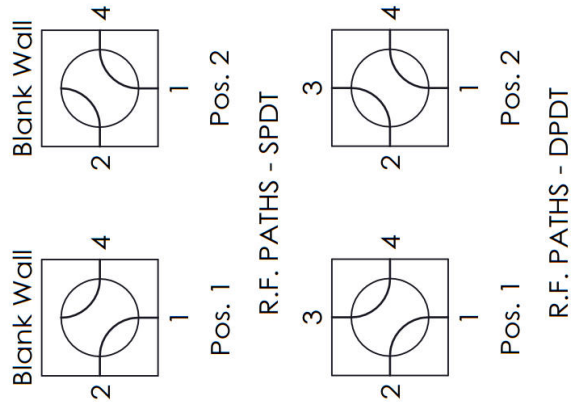

DWG TITLE

PEWGS60

CAGE CODE 53919

SCALE N/A

SIZE A

2233

NOTES:

1. UNLESS OTHERWISE SPECIFIED ALL DIMENSIONS ARE NOMINAL.
2. ALL SPECIFICATIONS ARE SUBJECT TO CHANGE WITHOUT NOTICE AT ANY TIME.
3. DIMENSIONS ARE IN INCHES [mm].

PE PASTERNAK
THE ENGINEER'S RF SOURCE

Pasternack Enterprises, Inc.
P.O. Box 16759 | Irvine | CA | 92623

Phone: (949) 261-1920 | Fax: (949) 261-7451
Website: www.pasternack.com | E-Mail: sales@pasternack.com