



SMA Male Right Angle to SMA Male Right Angle Low PIM Cable 36 Inch Length Using 1/4 inch Superflexible Coax

RF Cable Assemblies Technical Data Sheet

PE3C7867-36

Configuration

- Connector 1: SMA Male Right Angle
- Connector 2: SMA Male Right Angle
- Cable Type: 1/4" Superflexible

Features

- Max Frequency 6 GHz
- Low PIM: -150 dBc Max
- Shielding Effectivity > 120 dB
- 82% Phase Velocity
- PE Jacket
- Low PIM and Low Loss
- 100% Tested with PIM Test Results Marked on Cable

Applications

- General Purpose
- Laboratory Use
- Low PIM Applications
- Distributed Antenna Systems (DAS)
- Low PIM Applications and PIM Testing

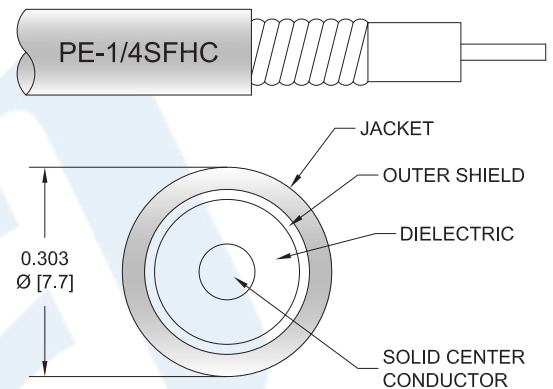

Description

Pasternack's PE3C7867-36 SMA male right angle to SMA male right angle 36 inch cable using 1/4 inch superflexible coax is part of our full line of RF components available for same-day shipping. Pasternack's corrugated RF cable assemblies are ideal for applications where durability and high power are needed. This Pasternack SMA to SMA cable assembly has a male to male gender configuration with 50 ohm corrugated 1/4" superflexible coax. The PE3C7867-36 SMA male to SMA male cable assembly operates to 6 GHz. Our low PIM design also offers excellent passive intermodulation performance with PIM levels better than -150 dBc. The right angle SMA interfaces on the 1/4" superflexible cable allow for easier connections in tight spaces.

Custom versions of most RF cable assemblies can be built and shipped same day. Custom cable assembly lengths can be obtained by specifying the desired length on the web site at time of order or by contacting a sales representative. Other available RF cable assembly value added services include connector orientation or clocking, heat shrink booting and custom labeling. RF testing can also be performed to document the electrical performance of your cable assembly.

Click the following link (or enter part number in "SEARCH" on website) to obtain additional part information including price, inventory and certifications: [SMA Male Right Angle to SMA Male Right Angle Low PIM Cable 36 Inch Length Using 1/4 inch Superflexible Coax PE3C7867-36](#)



SMA Male Right Angle to SMA Male Right Angle Low PIM
Cable 36 Inch Length Using 1/4 inch Superflexible Coax

RF Cable Assemblies Technical Data Sheet

PE3C7867-36

Electrical Specifications

Description	Minimum	Typical	Maximum	Units
Frequency Range	DC		6	GHz
VSWR			1.5:1	
Velocity of Propagation		82		%
RF Shielding	120			dB
Passive Intermodulation			-150	dBc
Capacitance		24.4 [80.05]		pF/ft [pF/m]
Inductance		0.059 [0.19]		uH/ft [uH/m]
DC Resistance Inner Conductor		3.2 [10.5]		Ω /1000ft [Ω /Km]
DC Resistance Outer Conductor		2.53 [8.3]		Ω /1000ft [Ω /Km]
Jacket Spark			2,000	Vrms

Specifications by Frequency

Description	F1	F2	F3	F4	F5	Units
Frequency	0.1	0.25	0.5	1	3	GHz
Insertion Loss (Typ.)	0.34	0.38	0.41	0.47	0.62	dB

Electrical Specification Notes:

The Insertion Loss data above is based on the performance specifications of the coax and connectors used in this assembly. The Insertion Loss includes an estimated insertion loss of 0.3dB of connector loss.

Mechanical Specifications

Cable Assembly

Length* 36 in [914.4 mm]
Diameter 0.36 in [9.14 mm]

Cable

Cable Type 1/4" Superflexible
Impedance 50 Ohms
Inner Conductor Type Solid
Inner Conductor Material and Plating Copper Clad Aluminum
Dielectric Type PE (F)
Number of Shields 1
Shield Layer 1 Helically Corrugated Copper Tube
Jacket Material PE, Black
Jacket Diameter 0.303 in [7.7 mm]

Click the following link (or enter part number in "SEARCH" on website) to obtain additional part information including price, inventory and certifications: [SMA Male Right Angle to SMA Male Right Angle Low PIM Cable 36 Inch Length Using 1/4 inch Superflexible Coax PE3C7867-36](#)



SMA Male Right Angle to SMA Male Right Angle Low PIM
Cable 36 Inch Length Using 1/4 inch Superflexible Coax

RF Cable Assemblies Technical Data Sheet

PE3C7867-36

One Time Minimum Bend Radius	0.5 in [12.7 mm]
Repeated Minimum Bend Radius	1 in [25.4 mm]
Typical Flex Cycles	20
Tensile Strength	79 lbs [35.83 Kg]

Connectors

Description	Connector 1	Connector 2
Type	SMA Male Right Angle	SMA Male Right Angle
Specification	SMA	SMA
Impedance	50 Ohms	50 Ohms
Contact Material and Plating	Brass, Silver	Brass, Silver
Dielectric Type	PTFE	PTFE
Body Material and Plating	Brass, Tri-Metal	Brass, Tri-Metal
Coupling Nut Material and Plating	Brass, Tri-Metal	Brass, Tri-Metal

Environmental Specifications

Temperature

Operating Range	-40 to +85 deg C
-----------------	------------------

Compliance Certifications (see [product page](#) for current document)

Plotted and Other Data

Notes:

Click the following link (or enter part number in "SEARCH" on website) to obtain additional part information including price, inventory and certifications: [SMA Male Right Angle to SMA Male Right Angle Low PIM Cable 36 Inch Length Using 1/4 inch Superflexible Coax PE3C7867-36](#)



SMA Male Right Angle to SMA Male Right Angle Low PIM Cable 36 Inch Length Using 1/4 inch Superflexible Coax

RF Cable Assemblies Technical Data Sheet

PE3C7867-36

How to Order

Part Number Configuration:

PE3C7867

- **xx**

uu

Unit of Measure:
cm = Centimeters
<blank> = Inches
Length
Base Number

Example: PE3C7867-12 = 12 inches long cable
PE3C7867-100cm = 100 cm long cable

SMA Male Right Angle to SMA Male Right Angle Low PIM Cable 36 Inch Length Using 1/4 inch Superflexible Coax from Pasternack Enterprises has same day shipment for domestic and International orders. Our RF, microwave and millimeter wave products maintain a 99.4% availability and are part of the broadest selection in the industry.

Click the following link (or enter part number in "SEARCH" on website) to obtain additional part information including price, inventory and certifications: [SMA Male Right Angle to SMA Male Right Angle Low PIM Cable 36 Inch Length Using 1/4 inch Superflexible Coax PE3C7867-36](https://www.pasternack.com/sma-male-sma-male-pe-1-4-sfhc-cable-assembly-pe3c7867-36-p.aspx)

URL: <https://www.pasternack.com/sma-male-sma-male-pe-1-4-sfhc-cable-assembly-pe3c7867-36-p.aspx>

The information contained in this document is accurate to the best of our knowledge and representative of the part described herein. It may be necessary to make modifications to the part and/or the documentation of the part, in order to implement improvements. Pasternack reserves the right to make such changes as required. Unless otherwise stated, all specifications are nominal. Pasternack does not make any representation or warranty regarding the suitability of the part described herein for any particular purpose, and Pasternack does not assume any liability arising out of the use of any part or documentation.

PE3C7867-36 CAD Drawing

SMA Male Right Angle to SMA Male Right Angle Low PIM Cable
36 Inch Length Using 1/4 inch Superflexible Coax

REVISIONS			
REV.	DESCRIPTION	DATE	APPROVED
A	INITIAL RELEASE	1/18/2021	S. ELLIS

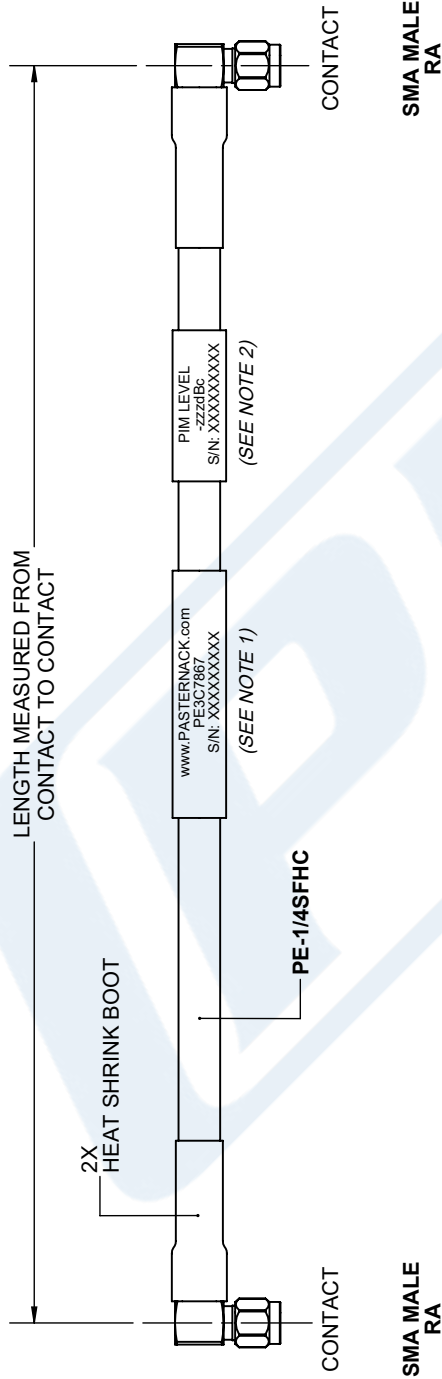

NOTES:

1. CABLES 84" AND UNDER HAVE 1 LABEL CENTERED. CABLES OVER 84" HAVE 2 LABELS, ONE AT EACH END 12.0" FROM THE END OF THE CONNECTOR.
2. 6" FROM CABLE END 1 PLACE FOR ALL LENGTHS OF CABLE.

THESE COMMODITIES, TECHNOLOGY OR SOFTWARE WERE EXPORTED FROM THE UNITED STATES IN ACCORDANCE WITH THE EXPORT ADMINISTRATION REGULATIONS. DIVERSION CONTRARY TO U.S. LAW PROHIBITED.

UNLESS OTHERWISE SPECIFIED LEADING DIMENSIONS ARE INCHES DIMENSIONS IN [] ARE MILLIMETERS	
TOLERANCES:	FRACTIONS
.X = ±.2 [.508]	±.1/32
.XX = ±.02 [.51]	±.1/32
.XXX = ±.005 [.13]	ANGLES ± 1°
CABLE LENGTH (L), TOLERANCES:	
L ≤ 12 [305]	±.1 [25] / -0
12 [305] < L ≤ 60 [1524]	±.2 [51] / -0
60 [1524] < L ≤ 120 [3048]	±.4 [102] / -0
120 [3048] < L ≤ 300 [7620]	±.6 [152] / -0
300 [7620] < L	±.5% [/ -0
ALL DIMENSIONS SHOWN ARE FOR REFERENCE ONLY.	



Pasternack Enterprises, Inc.
P. O. Box 16759, Irvine, CA 92623.
Phone: 1.949.261.1920 | 1.866.727.8376
Fax: 1.949.261.7451
Website: www.pasternack.com
E-mail: sales@pasternack.com

THIRD-ANGLE PROJECTION	THE INFORMATION AND DESIGN IN THIS DOCUMENT IS THE PROPERTY OF PASTERNAK CORPORATION ALL RIGHTS RESERVED.
SHEET 1 OF 1	SCALE N/A
REV	ITEM NO.
A	PE3C7867