

NOTICE OF PROPRIETARY RIGHTS THIS DOCUMENT CONTAINS CONFIDENTIAL TECHNICAL DATA, INCLUDING TRADE SECRETS, PROPRIETARY TO TIMES MICROWAVE SYSTEMS. DISCLOSURE OF THIS DATA IS EXPRESSLY CONDITIONED UPON YOUR ASSENT THAT ITS USE IS LIMITED TO USE WITHIN YOUR COMPANY ONLY. ANY OTHER USE IS STRICTLY PROHIBITED WITHOUT THE PRIOR WRITTEN CONSENT OF TIMES MICROWAVE SYSTEMS.

SYM	REVISION DESCRIPTION	DFTM	DATE	APPD	DATE
A	RELEASED FOR PRODUCTION	K.A.M.	6/3/11	J.D.B.	6/3/11
B	CHANGED PER CDC #34607/36250	D.J.H.	9/24/12	J.D.B.	9/25/12

RECOMMENDED CABLE STRIPPING DIM'S.

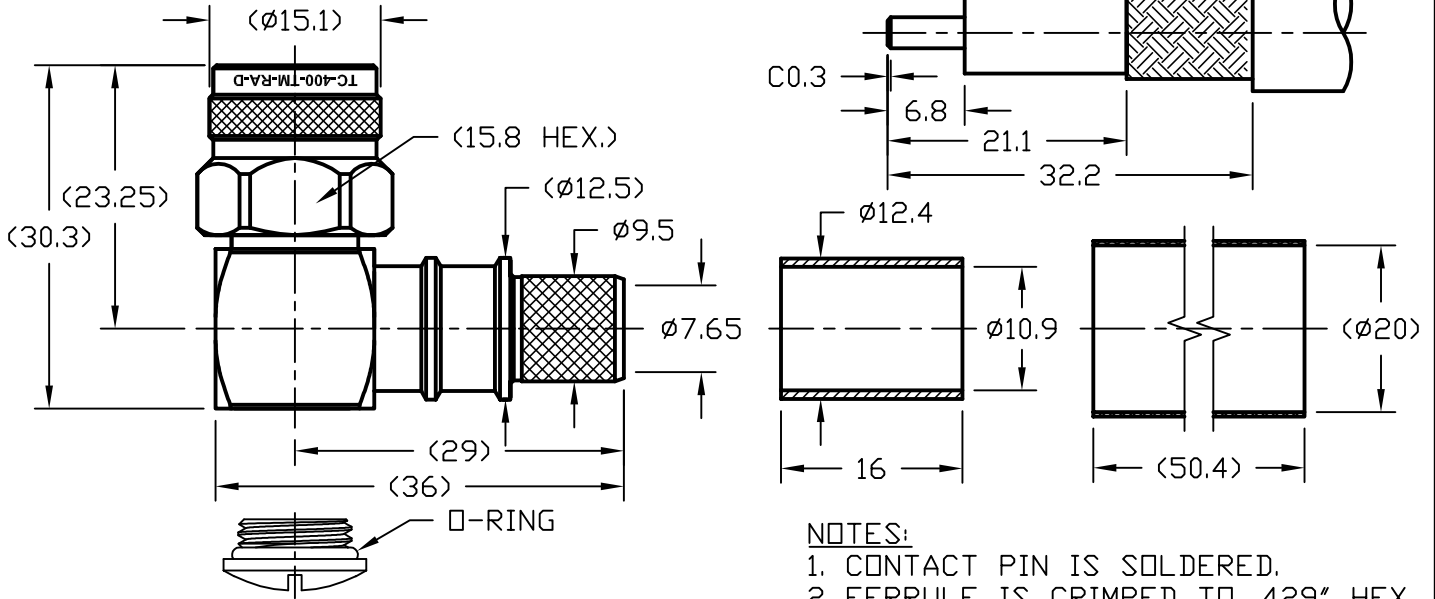

- NOTES:
 1. CONTACT PIN IS SOLDERED.
 2. FERRULE IS CRIMPED TO .429" HEX.

ALL PARTS SATISFIED ROHS REQUIREMENTS

MATERIALS AND PLATING		UNIT: MICRO-INCHES
BODY/SHELL	BRASS C3604	ALBALOY 80 MIN/COPPER
CONTACT PIN	BRASS C3604	GOLD 50 MIN/NICKEL/COPPER
INSULATOR	TEFLON MIL-P-19468	N/A
GASKET	SILICONE	RED
FERRULE	BRASS	ALBALOY 80 MIN/COPPER
SHRINK TUBING	PO	BLACK

ELECTRICAL CHARACTERISTICS	
Impedance	50 Ω
Frequency range	0~11GHz
Voltage rating	500V(rms)
Dielectric withstanding voltage	1000V
Contact resistance	Center contact ≤ 3 mΩ
	Outer contact ≤ 2 mΩ
Insulation resistance	≥ 5000MΩ
Insertion loss	According to the cable
RF-leakage	N/A
VSWR	≤ 1.35 MAX@0-6GHz

MECHANICAL CHARACTERISTICS	
Force to engage and disengage	N/A
Center contact retention force	6 lbs Min
Coupling torque	15 in-lbs Min
Coupling nut retention force	60 lbs Min
Durability	≥ 500 cycles

ENVIRONMENTAL CHARACTERISTICS	
Temperature range	-55°C - +125°C
Thermal Shock	MIL-STD-202, Method 107, Cond B
Vibration	MIL-STD-202, Method 204, Cond B
Shock	MIL-STD-202, Method 213, Cond I
Climatic Class	IEC 60068 55/155/56

MATERIAL: UNLESS OTHERWISE SPECIFIED	DFTM: K. A. M.	TIMES MICROWAVE SYSTEMS
	DATE: 6/3/11	
USED ON: 0-4	CHKD: J. D. B.	TC-400-TM-RA-D 90° TNC MALE FOR LMR400 CABLE
	DATE: 6/3/11	
SCALE: N/A	APPD: J. D. B.	1 of 1 SD3190-2671 B
	DATE: 6/3/11	
DWG. SIZE: A	DO NOT SCALE DRAWING	CODE IDENT: 68999

SMA Right Angle Male Connector Crimp Attachment for LMR-400, LMR-LW400, TCOM-400, LMR-400-LLPX, PE-B400, PE-B405, PE-C400, LMR-400-FR



PE5129

Configuration

- SMA Male Connector
- 50 Ohms
- Right Angle Body Geometry
- Connector Interface Types: LMR-400, LMR-LW400, TCOM-400, LMR-400-LLPX, PE-B400, PE-B405, PE-C400, LMR-400-FR

Features

- Max. Operating Frequency 6 GHz
- Gold Plated Brass Contact

Applications

- General Purpose Test
- Custom Cable Assemblies

Description

Pasternack's PE5129 Right Angle, SMA, Connector is part of our full line of RF components available for same-day shipping. Our Right Angle, SMA male connector operates up to a maximum frequency of 6 GHz. Its right angle body geometry allows for easier connections in tight spaces.

Our SMA male right angle connector PE5129 datasheet specifications and drawing with dimensions are shown below in this PDF. Pasternack's broad catalog of RF, microwave and millimeter wave connectors allows designers to configure and customize their signal connections however they like. Whether the need is to provide an I/O for a board design, or simply create a custom cable assembly configuration, Pasternack has the right connector for the job. Pasternack can also expertly build your custom cable assemblies for you and ship same-day.

Electrical Specifications

Description	Minimum	Typical	Maximum	Units
Frequency Range	DC		6	GHz
Insulation Resistance	5,000			MOhms
Impedance		50		Ohms

Performance by Frequency

Description	F1	F2	F3	F4	F5	Units
Frequency Range	DC to 3					GHz
VSWR, Max	1.25:1					

Mechanical Specifications

Size

Length	1.35 in [34.29 mm]
Width	0.91 in [23.11 mm]
Height	0.49 in [12.45 mm]
Weight	0.047 lbs [21.32 g]

SMA Right Angle Male Connector Crimp Attachment for LMR-400, LMR-LW400, TCOM-400, LMR-400-LLPX, PE-B400, PE-B405, PE-C400, LMR-400-FR



PE5129

Material Specifications

Description	Material	Plating
Contact	Brass	Gold
Insulation	PTFE	
Body	Brass	Tri-metal
Gasket	Silicone Rubber	
Crimp Sleeve	Brass	Tri-metal

Environmental Specifications

Temperature
Operating Range -40 to +155 deg C

Compliance Certifications (see [product page](#) for current document)

Plotted and Other Data

Notes:

SMA Right Angle Male Connector Crimp Attachment
for LMR-400, LMR-LW400, TCOM-400, LMR-400-LLPX, PE-B400, PE-B405, PE-C400, LMR-400-FR



PE5129

Assembly Instruction

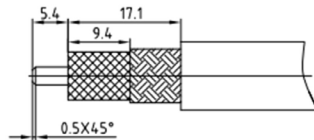
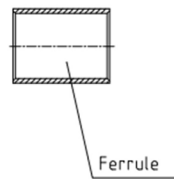
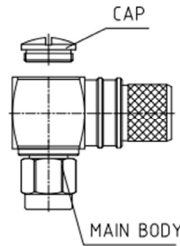

- 1.A. Stripping dimension is as shown by diagram, attention should be paid while stripping.
- B. Remove residual burr.

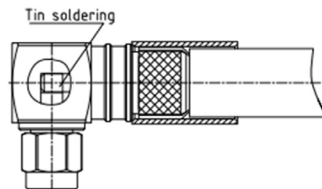

- 2.A. Put the connector in place, Then push the ferrule.
- B. Solder inner conduct.
- C. Remove residual burr.

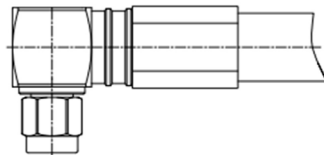

- 3.A. Compression crimping sleeve
- B. Push the heat shrink tube, blow it with heat gun.

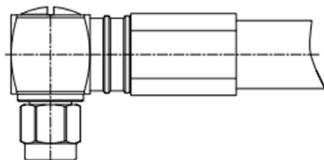

- 3.A. Screw on the end cap.

SMA Right Angle Male Connector Crimp Attachment for LMR-400, LMR-LW400, TCOM-400, LMR-400-LLPX, PE-B400, PE-B405, PE-C400, LMR-400-FR



PE5129

SMA Right Angle Male Connector Crimp Attachment for LMR-400, LMR-LW400, TCOM-400, LMR-400-LLPX, PE-B400, PE-B405, PE-C400, LMR-400-FR from Pasternack Enterprises has same day shipment for domestic and International orders. Our RF, microwave and millimeter wave products maintain a 99.4% availability and are part of the broadest selection in the industry.

Click the following link (or enter part number in "SEARCH" on website) to obtain additional part information including price, inventory and certifications: [SMA Right Angle Male Connector Crimp Attachment for LMR-400, LMR-LW400, TCOM-400, LMR-400-LLPX, PE-B400, PE-B405, PE-C400, LMR-400-FR PE5129](https://www.pasternack.com/sma-male-lmr-400-lmr-lw400-lmr-400-llpx-connector-pe5129-p.aspx)

URL: <https://www.pasternack.com/sma-male-lmr-400-lmr-lw400-lmr-400-llpx-connector-pe5129-p.aspx>

The information contained within this document is accurate to the best of our knowledge and representative of the part described herein. It may be necessary to make modifications to the part and/or the documentation of the part in order to implement improvements. Pasternack Enterprises reserves the right to make such changes as required. Unless otherwise stated, all specifications are nominal. Pasternack Enterprises does not make any representation or warranty regarding the suitability of the part described herein for any particular purpose, and Pasternack Enterprises does not assume liability arising out of the use of any part or document.

PE5129 CAD Drawing

SMA Right Angle Male Connector Crimp Attachment for LMR-400, LMR-LW400, TCOM-400, LMR-400-LLPX, PE-B400, PE-B405, PE-C400, LMR-400-FR

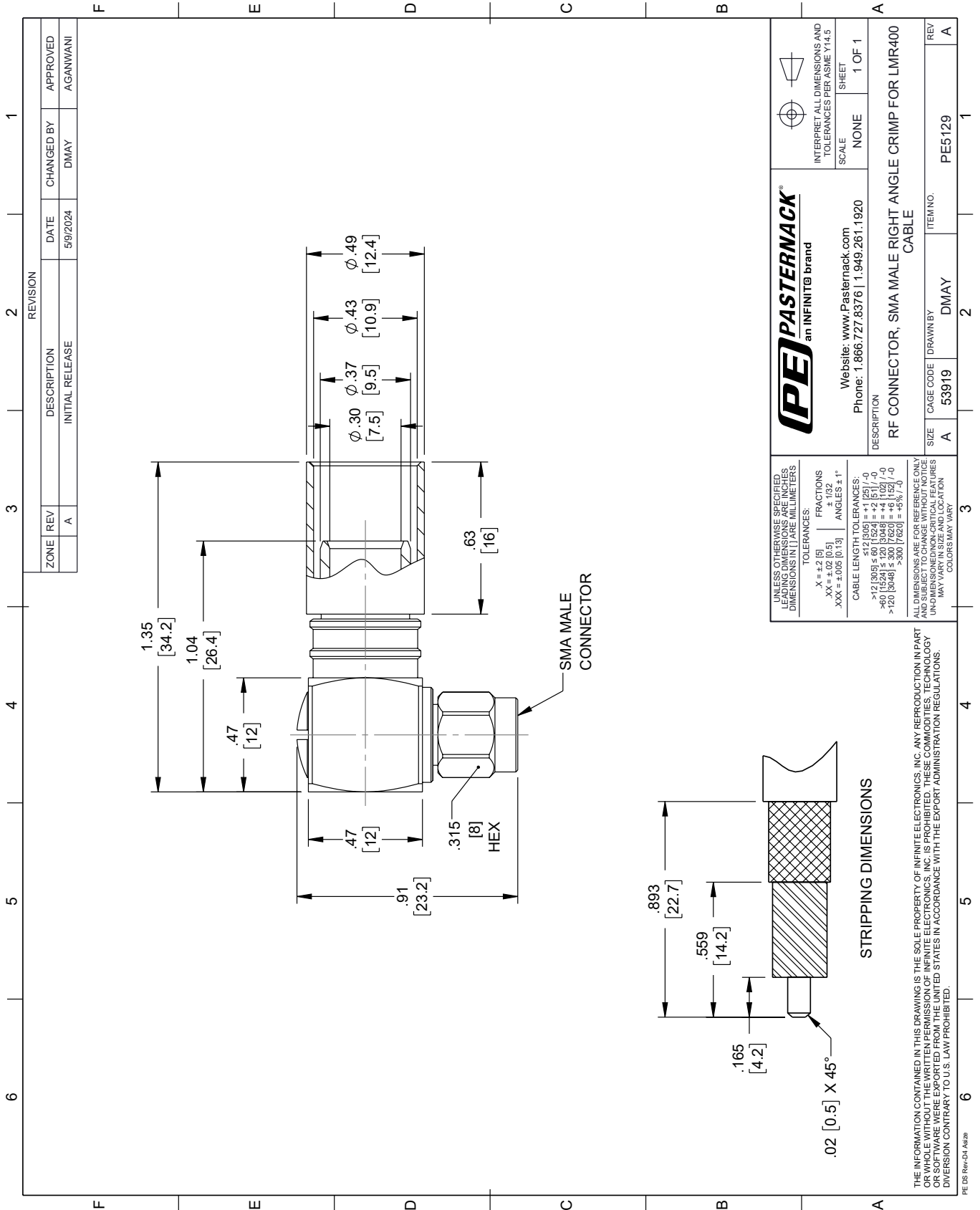

REVISION		DATE	CHANGED BY	APPROVED	
ZONE	REV	DESCRIPTION	DATE	CHANGED BY	APPROVED
	A	INITIAL RELEASE	5/9/2024	DMAY	AGANWANI

PE PASTERNAK
an INFINITE brand

Website: www.Pasternack.com
Phone: 1.866.727.8376 | 1.949.261.1920

INTERPRET ALL DIMENSIONS AND TOLERANCES PER ASME Y14.5

SCALE: NONE SHEET: 1 OF 1

DESCRIPTION: RF CONNECTOR, SMA MALE RIGHT ANGLE CRIMP FOR LMR400 CABLE

SIZE: A CAGE CODE: DMAY ITEM NO.: PE5129

REV: A

UNLESS OTHERWISE SPECIFIED, LEADING DIMENSIONS ARE IN INCHES. DIMENSIONS IN [] ARE MILLIMETERS.

TOLERANCES:
 .X = ±.2 [5]
 .XX = ±.02 [0.5]
 .XXX = ±.005 [0.13]

FRACTIONS: ± 1/32
 ANGLES: ± 1°

CABLE LENGTH TOLERANCES:
 <12 [305] ≤ 60 [1524] = ±.1 [25] / -0
 >60 [1524] ≤ 120 [3048] = ±.4 [102] / -0
 >120 [3048] ≤ 300 [7620] = ±.6 [15] / -0
 >300 [7620] = ±.8 [20] / -0

ALL DIMENSIONS ARE FOR REFERENCE ONLY. UNDIMENSIONED/UNCLEAR FEATURES MAY VARY IN SIZE AND LOCATION. COLORS MAY VARY.

THE INFORMATION CONTAINED IN THIS DRAWING IS THE SOLE PROPERTY OF INFINITE ELECTRONICS, INC. ANY REPRODUCTION IN PART OR WHOLE WITHOUT THE WRITTEN PERMISSION OF INFINITE ELECTRONICS, INC. IS PROHIBITED. THESE COMMODITIES, TECHNOLOGY OR SERVICES ARE NOT EXPORTED FROM THE UNITED STATES IN ACCORDANCE WITH THE EXPORT ADMINISTRATION REGULATIONS. DIVISION CONTRARY TO U.S. LAW PROHIBITED.

PE DS Rev-04 Add2

Low Loss Flexible LMR-400 Outdoor Rated Coax Cable Double Shielded with Black PE Jacket

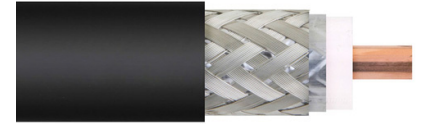

LMR-400



Times Microwave Systems Connector Specification

Configuration

- Low Loss, Outdoor Flexible Cable
- 2 Shield(s)

Features

- Flexible Low Loss Communications Coax
- Max Operating Frequency of 8 GHz
- Replacement for Air Dielectric type RG8 cable
- Double Shields provides RF Shielding in excess of 90 db
- Low Loss size for size compared to standard flexible cable

Applications

- Laboratory Applications
- General Purpose RF Interconnect

Description

LMR-400 part number from Pasternack is a LMR-400 coax cable that is flexible. Pasternack LMR-400 flexible coax cable is 50 Ohm and has a PE (F) dielectric. Our LMR-400 coax is constructed with a 0.405 jacket made of PE. LMR-400 coax has a shield count of 2, a RF shielding of 90 dB and the maximum frequency for this Pasternack cable is 8 GHz. LMR-400 coax cable has an attenuation at 1 GHz of 4.25 dB.

Pasternack LMR-400 coax cables are part of over 40,000 RF, microwave and millimeter wave components. LMR-400 cables and our other RF parts are available for same day shipping worldwide. Custom RF cable assemblies using LMR-400 or other coax can be built and shipped same day as well.

* LMR™ is a trademark of Times Microwave Systems.

Electrical Specifications

Description	Minimum	Typical	Maximum	Units
Frequency Range	DC		8	GHz
Impedance		50		Ohms
Velocity of Propagation		85		%
Time Delay		1.2 [3.94]		ns/ft [ns/m]
Shielding Effectiveness	90			dB
Dielectric Withstanding Voltage (DC)			2,500	Vdc
Jacket Spark			8,000	Vrms
Inner Conductor DC Resistance			1.39	Ohms/1000ft
Outer Conductor DC Resistance			1.65	Ohms/1000ft
Nominal Capacitance		23.9 [78.41]		pF/ft [pF/m]
Nominal Inductance		0.06 [0.2]		uH/ft [uH/m]
Input Power (Peak)			16	kWatts

Low Loss Flexible LMR-400 Outdoor Rated Coax Cable Double Shielded with Black PE Jacket

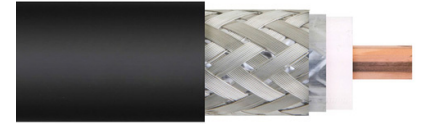

LMR-400

Performance by Frequency Band

Description	F1	F2	F3	F4	F5	Units
Frequency	50	150	220	450	900	MHz
Attenuation, Typ	0.9	1.5	1.9	2.7	3.9	dB/100ft
	2.95	4.92	6.23	8.86	12.8	dB/100m
Input Power (CW), Max	2,570	1,470	1,200	830	580	Watts

Description	F6	F7	F8	F9	F10	Units
Frequency	1.5	1.8	2	2.5	8	GHz
Attenuation, Typ	5.1	5.7	6	6.8	10.8	dB/100ft
	16.73	18.7	19.69	22.31	35.43	dB/100m
Input Power (CW), Max	440	400	370	330	210	Watts

Mechanical Specifications

Diameter	0.405 in [10.29 mm]
Weight	0.067 lbs/ft [0.1 kg/m]
Min. Bend Radius (Installation)	1 in [25.4 mm]
Min. Bend Radius (Repeated)	4 in [101.6 mm]
Bending Moment	0.5 lbs-ft [0.68 N-m]
Tensile Strength	160 lbs [72.57 kg]
Flat Plate Crush	40 lbs/in [0.71 kg/mm]

Construction Specifications

Description	Material and Plating	Diameter
Inner Conductor	Copper Clad Aluminum, 1 Strand	0.108 in [2.74 mm]
Conductor Type	Solid	
Dielectric	PE (F)	0.285 in [7.24 mm]
First Shield	Aluminum Tape	0.29 in [7.37 mm]
Second Shield	Tinned Copper Braid	0.32 in [8.13 mm]
Jacket	PE, Black	0.405 in [10.29 mm]

Environmental Specifications

Temperature	
Operating Range	-40 to 85 deg C
Storage Range	-70 to 85 deg C

Compliance Certifications (see [product page](#) for current document)

Plotted and Other Data

Notes:

Low Loss Flexible LMR-400 Outdoor Rated Coax Cable Double Shielded with Black PE Jacket



LMR-400

Low Loss Flexible LMR-400 Outdoor Rated Coax Cable Double Shielded with Black PE Jacket from Pasternack Enterprises has same day shipment for domestic and International orders. Our RF, microwave and millimeter wave products maintain a 99.4% availability and are part of the broadest selection in the industry.

Click the following link (or enter part number in "SEARCH" on website) to obtain additional part information including price, inventory and certifications: [Low Loss Flexible LMR-400 Outdoor Rated Coax Cable Double Shielded with Black PE Jacket LMR-400](#)

URL: <https://www.pasternack.com/50-ohm-low-loss-flexible-lmr400-pe-jacket-double-shielded-black-lmr-400-p.aspx>

The information contained within this document is accurate to the best of our knowledge and representative of the part described herein. It may be necessary to make modifications to the part and/or the documentation of the part in order to implement improvements. Pasternack Enterprises reserves the right to make such changes as required. Unless otherwise stated, all specifications are nominal. Pasternack Enterprises does not make any representation or warranty regarding the suitability of the part described herein for any particular purpose, and Pasternack Enterprises does not assume liability arising out of the use of any part or document.

LMR-400 CAD Drawing

Low Loss Flexible LMR-400 Outdoor Rated Coax Cable Double Shielded with Black PE Jacket

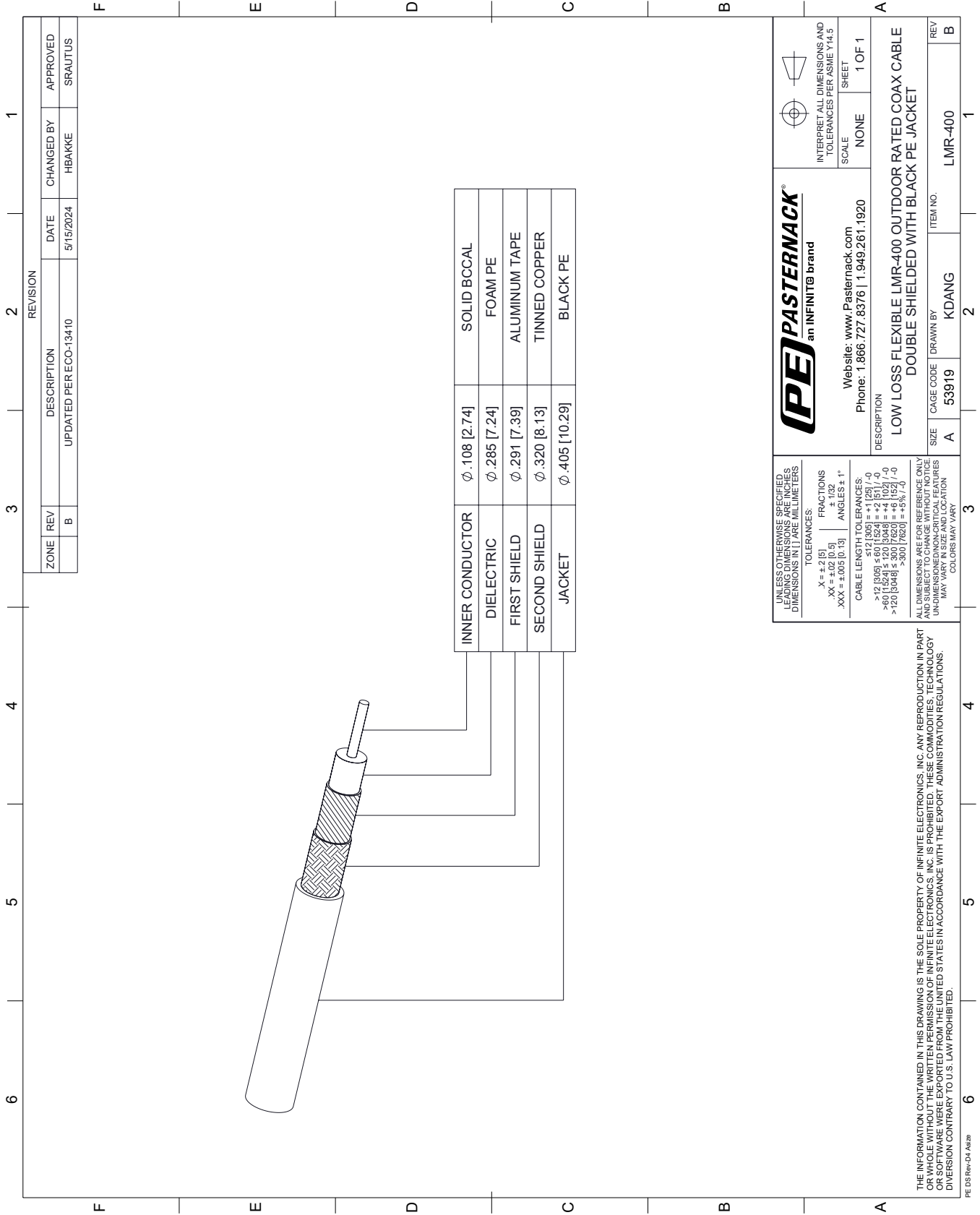

ZONE		REVISION	
REV	DESCRIPTION	DATE	CHANGED BY
B	UPDATED PER ECO-13410	5/15/2024	HBAKKE
			APPROVED
			SRAUTUS

	INTERPRET ALL DIMENSIONS AND TOLERANCES PER ASME Y14.5 SCALE: NONE SHEET: 1 OF 1
	Website: www.Pasternack.com Phone: 1.866.727.8376 1.949.261.1920
DESCRIPTION: LOW LOSS FLEXIBLE LMR-400 OUTDOOR RATED COAX CABLE DOUBLE SHIELDED WITH BLACK PE JACKET	
UNLESS OTHERWISE SPECIFIED, LEADING DIMENSIONS ARE INCHES AND DIMENSIONS IN [] ARE MILLIMETERS. TOLERANCES: .X = ±.2 [5] FRACTIONS ± 1/32 .XX = ±.02 [0.5] ANGLES ± 1° .XXX = ±.005 [0.13]	CAGE CODE: KDWANG DRAWN BY: A ITEM NO.: 53919
CABLE LENGTH TOLERANCES: ≤12 [305] = ±.125 [-0] ±12 [305] = +.125 [-0] ≤60 [1524] = ±.25 [-0] ±60 [1524] = +.25 [-0] ≤300 [7620] = ±1.25 [-0] ±300 [7620] = +1.25 [-0] >300 [7620] = ±.5% [-0] >300 [7620] = +.5% [-0]	ALL DIMENSIONS ARE FOR REFERENCE ONLY AND SUBJECT TO CHANGE WITHOUT NOTICE. UN-DIMENSIONED NON-CRITICAL FEATURES MAY VARY IN SIZE AND LOCATION. COLORS MAY VARY.

THE INFORMATION CONTAINED IN THIS DRAWING IS THE SOLE PROPERTY OF INFINITE ELECTRONICS, INC. ANY REPRODUCTION IN PART OR WHOLE OF THIS DRAWING WITHOUT THE WRITTEN PERMISSION OF INFINITE ELECTRONICS, INC. IS STRICTLY PROHIBITED. IF THIS DRAWING OR SOFTWARE WERE EXPORTED FROM THE UNITED STATES IN ACCORDANCE WITH THE EXPORT ADMINISTRATION REGULATIONS, DIVERSION CONTRARY TO U.S. LAW IS PROHIBITED.

PE DS Rev-D4 A829