



## N Male Connector Crimp/Non-Solder Contact Attachment for LMR-195, PE-C195, LMR-200, PE-C200

### RF Connectors Technical Data Sheet



**EZ-195-NMH-X**

#### Times Microwave Systems Connector Specification

##### Configuration

- N Male Connector
- MIL-STD-348
- 50 Ohms
- Straight Body Geometry
- Connector Interface Types: LMR-195, PE-C195, LMR-200, PE-C200

##### Features

- Max. Operating Frequency 6 GHz
- Good VSWR of 1.3:1
- Gold Plated Beryllium Copper Contact
- 50  $\mu$ m Thickness contact plating

##### Applications

- General Purpose Test
- Custom Cable Assemblies

##### Description

Pasternack's EZ-195-NMH-X type N, N, Standard, Connector is part of our full line of RF components available for same-day shipping. Our type N male connector operates up to a maximum frequency of 6 GHz and offers good VSWR of 1.3:1.

Our type N male connector EZ-195-NMH-X datasheet specifications and drawing with dimensions are shown below in this PDF. Pasternack's broad catalog of RF, microwave and millimeter wave connectors allows designers to configure and customize their signal connections however they like. Whether the need is to provide an I/O for a board design, or simply create a custom cable assembly configuration, Pasternack has the right connector for the job. Pasternack can also expertly build your custom cable assemblies for you and ship same-day.

##### Electrical Specifications

Description	Minimum	Typical	Maximum	Units
Frequency Range	DC		6	GHz
VSWR			1.3:1	
Insertion Loss			0.25	dB
Impedance		50		Ohms
Dielectric Withstanding Voltage (DC)			1,000	Vdc
Insulation Resistance	5,000			MOhms

##### Mechanical Specifications

###### Size

Length	1.27 in [32.26 mm]
Width	0.81 in [20.62 mm]
Height	0.81 in [20.62 mm]
Weight	0.08 lbs [35.83 g]
Mating Cycles	500 Cycles

Click the following link (or enter part number in "SEARCH" on website) to obtain additional part information including price, inventory and certifications: [N Male Connector Crimp/Non-Solder Contact Attachment for LMR-195, PE-C195, LMR-200, PE-C200 EZ-195-NMH-X](#)



# N Male Connector Crimp/Non-Solder Contact Attachment for LMR-195, PE-C195, LMR-200, PE-C200

## RF Connectors Technical Data Sheet



**EZ-195-NMH-X**

### Material Specifications

Description	Material	Plating
Contact	Beryllium Copper	Gold 50 µin Thickness
Insulation	PTFE	
Outer Conductor	Brass	Tri-Metal 80 µin Thickness
Body	Brass	Tri-Metal 80 µin Thickness
Coupling Nut	Brass	Tri-Metal 80 µin Thickness

### Environmental Specifications

#### Temperature

Operating Range

-40 to +125 deg C

Shock

MIL-STD 202G, Meth. 213, Cond. I

Vibration

MIL-STD 202G, Meth. 204, Cond.B

Thermal Shock

MIL-STD 202G, Meth. 107, Cond.B

**Compliance Certifications** (see [product page](#) for current document)

### Plotted and Other Data

Notes:

N Male Connector Crimp/Non-Solder Contact Attachment for LMR-195, PE-C195, LMR-200, PE-C200 from Pasternack Enterprises has same day shipment for domestic and International orders. Our RF, microwave and millimeter wave products maintain a 99.4% availability and are part of the broadest selection in the industry.

Click the following link (or enter part number in "SEARCH" on website) to obtain additional part information including price, inventory and certifications: [N Male Connector Crimp/Non-Solder Contact Attachment for LMR-195, PE-C195, LMR-200, PE-C200 EZ-195-NMH-X](#)

URL: <https://www.pasternack.com/n-male-lmr-195-pe-c195-connector-ez-195-nmh-x-p.aspx>

The information contained in this document is accurate to the best of our knowledge and representative of the part described herein. It may be necessary to make modifications to the part and/or the documentation of the part, in order to implement improvements. Pasternack reserves the right to make such changes as required. Unless otherwise stated, all specifications are nominal. Pasternack does not make any representation or warranty regarding the suitability of the part described herein for any particular purpose, and Pasternack does not assume any liability arising out of the use of any part or documentation.

**TIMES** MICROWAVE SYSTEMS **EZ-195-NMH-X CAD Drawing**  
 N Male Connector Crimp/Non-Solder Contact Attachment  
 for LMR-195, PE-C195, LMR-200, PE-C200

REVISIONS			
REV.	DESCRIPTION	DATE	APPROVED
A	INITIAL RELEASE	6/16/2022	A. GANWANI

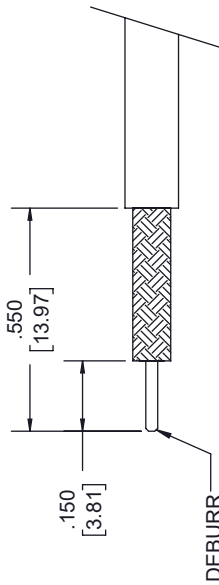
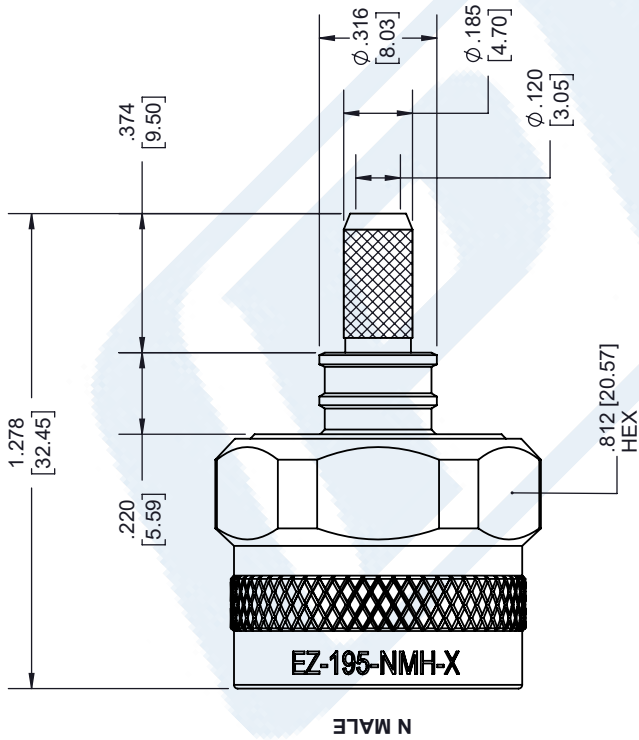
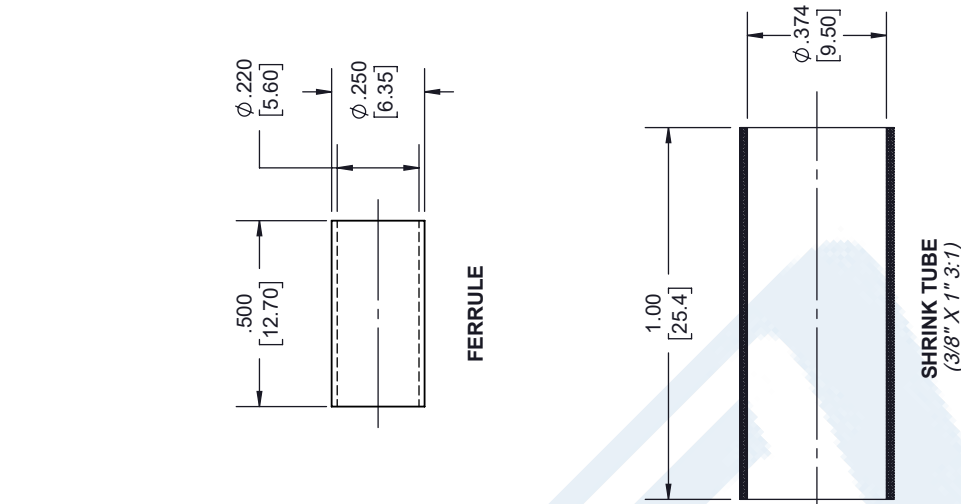

THIRD-ANGLE PROJECTION

THE INFORMATION AND DESIGN IN THIS DOCUMENT IS THE PROPERTY OF PASTERNAK CORPORATION. ALL RIGHTS RESERVED.

SHEET 1 OF 1

SCALE N/A

**PE PASTERNAK**  
an INFINITO brand

Pasternack Enterprises, Inc.  
 P.O. Box 16759, Irvine, CA 92623  
 Phone: 1.949.261.1920 | 1.866.727.8376  
 Fax: 1.949.261.7451  
 Website: www.pasternack.com  
 E-mail: sales@pasternack.com

SIZE A CAGE CODE A 53919 DRAWN BY K.DANG ITEM NO. EZ-195-NMH-X REV A

UNLESS OTHERWISE SPECIFIED LEADING DIMENSIONS ARE INCHES DIMENSIONS IN [ ] ARE MILLIMETERS

TOLERANCES:

X = ±.2	[5.08]	FRACTIONS	±.132
.XX = ±.02	[.51]		ANGLES ±.1°
.XXX = ±.005	[.13]		

CABLE LENGTH (L) TOLERANCES:

L ≤ 12 [305]	= +1 [25] / -0
12 [305] < L ≤ 60 [1524]	= +2 [51] / -0
60 [1524] < L ≤ 120 [3048]	= +4 [102] / -0
120 [3048] < L ≤ 300 [7620]	= +6 [152] / -0
300 [7620] < L	= +5% L / -0

ALL DIMENSIONS SHOWN ARE FOR REFERENCE ONLY.

- NOTES:
- CABLE ATTACHMENT:
    - OUTER: CRIMP.
    - INNER: SOLDER.
  - CRIMP SIZE REQUIRED:
    - FERRULE: .213 [5.41] HEX. CRIMP TOOL.
    - CONTACT: SOLDER.
- THESE COMMODITIES, TECHNOLOGY OR SOFTWARE WERE EXPORTED FROM THE UNITED STATES IN ACCORDANCE WITH THE EXPORT ADMINISTRATION REGULATIONS. DIVERSION CONTRARY TO U.S. LAW PROHIBITED.



## N Male Connector Crimp/Non-Solder Contact Attachment for LMR-195, PE-C195, LMR-200, PE-C200

### RF Connectors Technical Data Sheet



**EZ-195-NMH-X**

#### Times Microwave Systems Connector Specification

##### Configuration

- N Male Connector
- MIL-STD-348
- 50 Ohms
- Straight Body Geometry
- Connector Interface Types: LMR-195, PE-C195, LMR-200, PE-C200

##### Features

- Max. Operating Frequency 6 GHz
- Good VSWR of 1.3:1
- Gold Plated Beryllium Copper Contact
- 50  $\mu$ m Thickness contact plating

##### Applications

- General Purpose Test
- Custom Cable Assemblies

##### Description

Pasternack's EZ-195-NMH-X type N, N, Standard, Connector is part of our full line of RF components available for same-day shipping. Our type N male connector operates up to a maximum frequency of 6 GHz and offers good VSWR of 1.3:1.

Our type N male connector EZ-195-NMH-X datasheet specifications and drawing with dimensions are shown below in this PDF. Pasternack's broad catalog of RF, microwave and millimeter wave connectors allows designers to configure and customize their signal connections however they like. Whether the need is to provide an I/O for a board design, or simply create a custom cable assembly configuration, Pasternack has the right connector for the job. Pasternack can also expertly build your custom cable assemblies for you and ship same-day.

##### Electrical Specifications

Description	Minimum	Typical	Maximum	Units
Frequency Range	DC		6	GHz
VSWR			1.3:1	
Insertion Loss			0.25	dB
Impedance		50		Ohms
Dielectric Withstanding Voltage (DC)			1,000	Vdc
Insulation Resistance	5,000			MOhms

##### Mechanical Specifications

###### Size

Length	1.27 in [32.26 mm]
Width	0.81 in [20.62 mm]
Height	0.81 in [20.62 mm]
Weight	0.08 lbs [35.83 g]
Mating Cycles	500 Cycles

Click the following link (or enter part number in "SEARCH" on website) to obtain additional part information including price, inventory and certifications: [N Male Connector Crimp/Non-Solder Contact Attachment for LMR-195, PE-C195, LMR-200, PE-C200 EZ-195-NMH-X](#)



## N Male Connector Crimp/Non-Solder Contact Attachment for LMR-195, PE-C195, LMR-200, PE-C200

### RF Connectors Technical Data Sheet

#### Material Specifications

Description	Material	Plating
Contact	Beryllium Copper	Gold 50 µin Thickness
Insulation	PTFE	
Outer Conductor	Brass	Tri-Metal 80 µin Thickness
Body	Brass	Tri-Metal 80 µin Thickness
Coupling Nut	Brass	Tri-Metal 80 µin Thickness

#### Environmental Specifications

##### Temperature

Operating Range

-40 to +125 deg C

Shock

MIL-STD 202G, Meth. 213, Cond. I

Vibration

MIL-STD 202G, Meth. 204, Cond.B

Thermal Shock

MIL-STD 202G, Meth. 107, Cond.B

#### Compliance Certifications (see [product page](#) for current document)

#### Plotted and Other Data

Notes:

N Male Connector Crimp/Non-Solder Contact Attachment for LMR-195, PE-C195, LMR-200, PE-C200 from Pasternack Enterprises has same day shipment for domestic and International orders. Our RF, microwave and millimeter wave products maintain a 99.4% availability and are part of the broadest selection in the industry.

Click the following link (or enter part number in "SEARCH" on website) to obtain additional part information including price, inventory and certifications: [N Male Connector Crimp/Non-Solder Contact Attachment for LMR-195, PE-C195, LMR-200, PE-C200 EZ-195-NMH-X](#)

URL: <https://www.pasternack.com/n-male-lmr-195-pe-c195-connector-ez-195-nmh-x-p.aspx>

The information contained in this document is accurate to the best of our knowledge and representative of the part described herein. It may be necessary to make modifications to the part and/or the documentation of the part, in order to implement improvements. Pasternack reserves the right to make such changes as required. Unless otherwise stated, all specifications are nominal. Pasternack does not make any representation or warranty regarding the suitability of the part described herein for any particular purpose, and Pasternack does not assume any liability arising out of the use of any part or documentation.

**TIMES** MICROWAVE SYSTEMS **EZ-195-NMH-X CAD Drawing**  
 N Male Connector Crimp/Non-Solder Contact Attachment  
 for LMR-195, PE-C195, LMR-200, PE-C200

REVISIONS			
REV.	DESCRIPTION	DATE	APPROVED
A	INITIAL RELEASE	6/16/2022	A. GANWANI

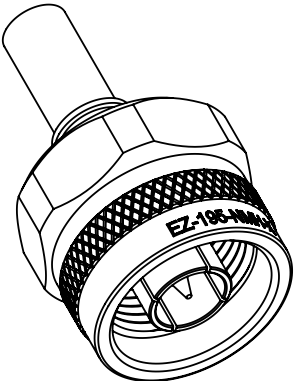
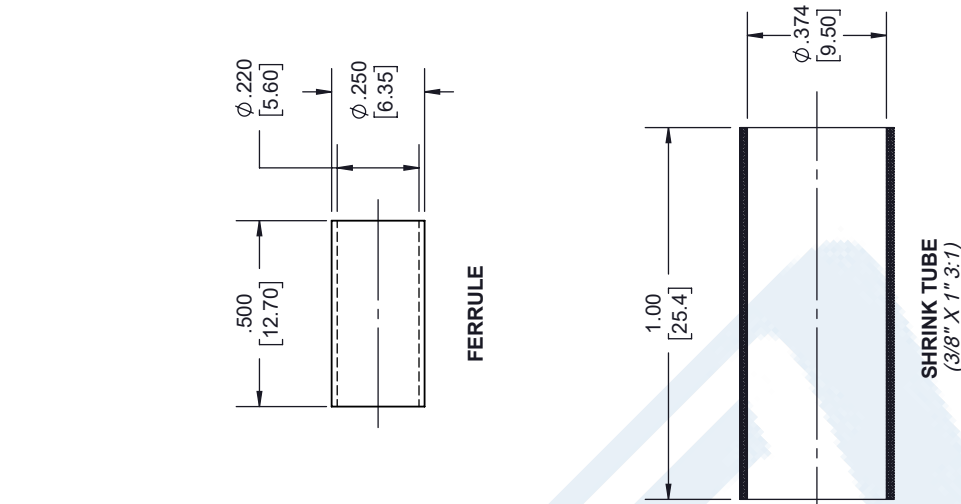

**STRIPPING DIMENSIONS**

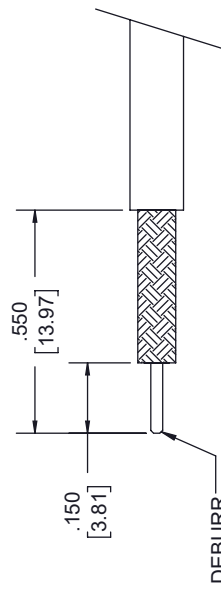

- NOTES:**
- CABLE ATTACHMENT:
    - OUTER: CRIMP.
    - INNER: SOLDER.
  - CRIMP SIZE REQUIRED:
    - FERRULE: .213 [5.41] HEX. CRIMP TOOL.
    - CONTACT: SOLDER.

UNLESS OTHERWISE SPECIFIED LEADING DIMENSIONS ARE INCHES DIMENSIONS IN [ ] ARE MILLIMETERS

**TOLERANCES:**

X = ±.2	[5.08]	FRACTIONS	±.132
.XX = ±.02	[.51]	ANGLES	± 1°
.XXX = ±.005	[.13]	CABLE LENGTH (L)	TOLERANCES:
		L ≤ 12 [305]	= +1 [25] / -0
		12 [305] < L ≤ 60 [1524]	= +2 [51] / -0
		60 [1524] < L ≤ 120 [3048]	= +4 [102] / -0
		120 [3048] < L ≤ 300 [7620]	= +6 [152] / -0
		300 [7620] < L = +5% L / -0	

ALL DIMENSIONS SHOWN ARE FOR REFERENCE ONLY.

**THIRD-ANGLE PROJECTION**

THE INFORMATION AND DESIGN IN THIS DOCUMENT IS THE PROPERTY OF PASTERNAK CORPORATION ALL RIGHTS RESERVED.

SHEET 1 OF 1

SCALE N/A

**PE PASTERNAK**  
 an INFINITO brand

Pasternack Enterprises, Inc.  
 P.O. Box 16759, Irvine, CA 92623  
 Phone: 1.949.261.1920 | 1.866.727.8376  
 Fax: 1.949.261.7451  
 Website: www.pasternack.com  
 E-mail: sales@pasternack.com

SIZE	CAGE CODE	DRAWN BY	ITEM NO.
A	53919	K.DANG	EZ-195-NMH-X

REV A

THESE COMMODITIES, TECHNOLOGY OR SOFTWARE WERE EXPORTED FROM THE UNITED STATES IN ACCORDANCE WITH THE EXPORT ADMINISTRATION REGULATIONS. DIVERSION CONTRARY TO U.S. LAW PROHIBITED.

## Low PIM Flexible TCOM-195 Coax Cable Triple Shielded with Black PE Jacket

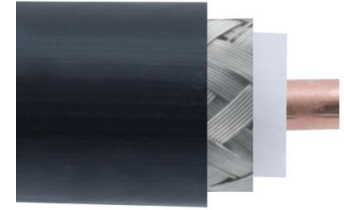

### TCOM-195

#### Configuration

- Low PIM Flexible Cable
- 3 Shield(s)

#### Features

- Lightweight and Extremely Flexible
- PIM < -155 dBc
- RF Shielding >100 dB
- Low Loss Dielectric 80% VoP
- UV Resistant, Life Expectancy > 20 Years

#### Applications

- Wireless Base Station Interconnect
- Distributed Antenna Systems (DAS)
- Outdoor Applications
- Antenna Jumpers
- Small Cell

#### Description

The TCOM-195 part number from Pasternack is a TCOM-195 low PIM coax cable that is flexible. Pasternack flexible coax RF cable has an impedance of 50 Ohm and a foam polyethylene dielectric. Our TCOM-195 coax cable is constructed with a 0.195-inch jacket made of polyethylene. This coaxial cable has a dielectric withstanding voltage of 1000 Vdc. This black low PIM coax cable has a nominal capacitance of 25.40 pF/Ft

This TCOM-195 flexible RF cable has a shield count of 3. Our coax cable from Pasternack has a maximum frequency of 18 GHz. The maximum passive intermodulation of this low PIM cable is -155 dBc. Additional specifications for this TCOM-195 RF coaxial cable are on our downloadable PDF datasheet above. This low PIM RF cable has a one-time minimum bend radius of 0.5 inches and a repeat minimum bend radius of 2 inches. Our flexible 50 Ohm coax cable has a peak power rating of 2500 watts.

Our TCOM-195 coax cable can operate at temperatures ranging from -40 to 85 deg C. The black-colored coax RF cable has a typical insertion loss/attenuation of 4.5, 8, 11, 17, 27, 39, and 54 dB/100ft at frequencies of 150 MHz, 450 MHz, 900 MHz, 2000 MHz, 5000 MHz, 10000 MHz and 18000 MHz respectively. Our TCOM-195 flexible RF cable has a solid copper center conductor. This coaxial cable features a dual shield of tinned copper braid over the silver plated copper braid.

Pasternack TCOM-195 low PIM coax cables are part of our RF, microwave, and millimeter wave components. These flexible cables and our other RF parts are available for same-day shipping worldwide. Custom RF cable assemblies using TCOM-195, or other coax can be built and shipped the same business day as well.

#### Electrical Specifications

Description	Minimum	Typical	Maximum	Units
Frequency Range	DC		18	GHz
Impedance		50		Ohms
Velocity of Propagation		80		%
Time Delay		1.27 [4.17]		ns/ft [ns/m]
Passive Intermodulation			-155	dBc
Dielectric Withstanding Voltage (DC)			1,000	Vdc
Jacket Spark			3,000	Vrms

## Low PIM Flexible TCOM-195 Coax Cable Triple Shielded with Black PE Jacket

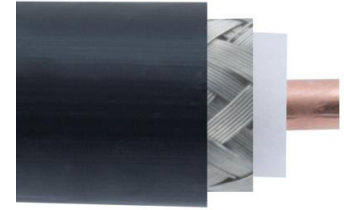

### TCOM-195

#### Electrical Specifications

Description	Minimum	Typical	Maximum	Units
Inner Conductor DC Resistance			7.16	Ohms/1000ft
Outer Conductor DC Resistance			3.42	Ohms/1000ft
Nominal Capacitance		25.4 [83.33]		pF/ft [pF/m]
Nominal Inductance		0.064 [0.21]		uH/ft [uH/m]
Input Power (Peak)			2.5	kWatts

#### Performance by Frequency Band

Description	F1	F2	F3	F4	F5	Units
Frequency	0.15	0.45	0.9	2	5	GHz
Attenuation, Typ	4.5	8	11	17	27	dB/100ft
	14.76	26.25	36.09	55.77	88.58	dB/100m

Description	F6	F7	F8	F9	F10	Units
Frequency	10	18				GHz
Attenuation, Typ	39	54				dB/100ft
	127.95	177.17				dB/100m

#### Mechanical Specifications

Diameter	0.195 in [4.95 mm]
Weight	0.035 lbs/ft [0.05 kg/m]
Min. Bend Radius (Installation)	0.5 in [12.7 mm]
Min. Bend Radius (Repeated)	2 in [50.8 mm]
Bending Moment	0.2 lbs-ft [0.27 N-m]
Flat Plate Crush	15 lbs/in [0.27 kg/mm]

#### Construction Specifications

Description	Material and Plating	Diameter
Inner Conductor	Copper, 1 Strand	0.037 in [0.94 mm]
Conductor Type	Solid	
Dielectric	PE (F)	0.11 in [2.79 mm]
First Shield	Silver Plated Copper Braid	0.12 in [3.05 mm]
Second Shield	Tinned Copper Braid over Aluminum Tape	0.148 in [3.76 mm]
Jacket	PE, Black	0.195 in [4.95 mm]

#### Environmental Specifications

<b>Temperature</b>	
Operating Range	-40 to +85 deg C

## Low PIM Flexible TCOM-195 Coax Cable Triple Shielded with Black PE Jacket



### TCOM-195

---

Installation Range	-40 to +85 deg C
Storage Range	-70 to +85 deg C

**Compliance Certifications** (see [product page](#) for current document)

#### Plotted and Other Data

Notes:

Low PIM Flexible TCOM-195 Coax Cable Triple Shielded with Black PE Jacket from Pasternack Enterprises has same day shipment for domestic and International orders. Our RF, microwave and millimeter wave products maintain a 99.4% availability and are part of the broadest selection in the industry.

Click the following link (or enter part number in "SEARCH" on website) to obtain additional part information including price, inventory and certifications: [Low PIM Flexible TCOM-195 Coax Cable Triple Shielded with Black PE Jacket TCOM-195](#)

URL: <https://www.pasternack.com/low-pim-flexible-tcom240-bulk-pe-jacket-silver-plated-copper-braid-over-tinned-copper-braid-outer-conductor-double-shielded-tcom-240-bulk-p.aspx>

The information contained within this document is accurate to the best of our knowledge and representative of the part described herein. It may be necessary to make modifications to the part and/or the documentation of the part in order to implement improvements. Pasternack Enterprises reserves the right to make such changes as required. Unless otherwise stated, all specifications are nominal. Pasternack Enterprises does not make any representation or warranty regarding the suitability of the part described herein for any particular purpose, and Pasternack Enterprises does not assume liability arising out of the use of any part or document.

# TCOM-195 CAD Drawing

Low PIM Flexible TCOM-195 Coax Cable Triple Shielded with Black PE Jacket

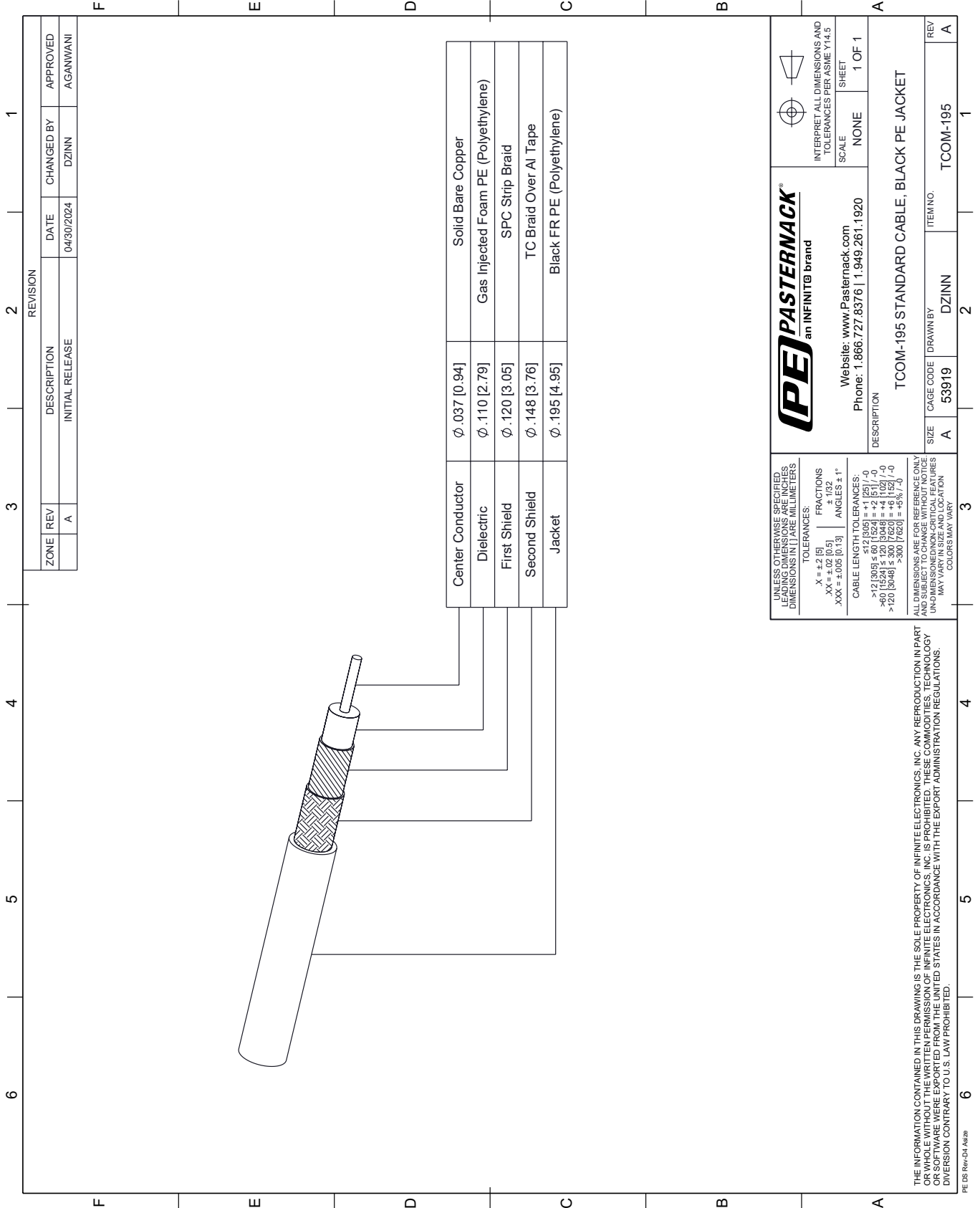

**(PE) PASTERNAK®**  
an INFINITE® brand

Website: [www.Pasternack.com](http://www.Pasternack.com)  
Phone: 1.866.727.8376 | 1.949.261.1920

SCALE: NONE  
SHEET: 1 OF 1

INTERPRET ALL DIMENSIONS AND TOLERANCES PER ASME Y14.5

DESCRIPTION: TCOM-195 STANDARD CABLE, BLACK PE JACKET

UNLESS OTHERWISE SPECIFIED, LEADING DIMENSIONS ARE IN INCHES AND DIMENSIONS IN [ ] ARE MILLIMETERS.

TOLERANCES:  
 .X = ±.2 [5]  
 .XX = ±.02 [0.5]  
 .XXX = ±.005 [0.13]  
 FRACTIONS: ± 1/32  
 ANGLES: ± 1°

CABLE LENGTH TOLERANCES:  
 <12 [305] ≤ 60 [1524] = ±1 [25] / -0  
 >60 [1524] ≤ 120 [3048] = ±4 [102] / -0  
 >120 [3048] ≤ 300 [7620] = ±5% / -0

ALL DIMENSIONS ARE FOR REFERENCE ONLY. UNDIMENSIONED/NON-CRITICAL FEATURES MAY VARY IN SIZE AND LOCATION. COLORS MAY VARY.

THE INFORMATION CONTAINED IN THIS DRAWING IS THE SOLE PROPERTY OF INFINITE ELECTRONICS, INC. ANY REPRODUCTION IN PART OR WHOLE WITHOUT THE WRITTEN PERMISSION OF INFINITE ELECTRONICS, INC. IS PROHIBITED. THESE COMMODITIES, TECHNOLOGY OR SERVICES ARE EXPORTED FROM THE UNITED STATES IN ACCORDANCE WITH THE EXPORT ADMINISTRATION REGULATIONS. DIVISION CONTRARY TO U.S. LAW PROHIBITED.

PE DS Rev-04 Add2